

DOCUMENT RESUME

ED 412 893

IR 018 351

AUTHOR Coley, Richard; Cradler, John; Engel, Penelope K.
TITLE Computers and Classrooms: The Status of Technology in U.S. Schools. Policy Information Report.
INSTITUTION Educational Testing Service, Princeton, NJ. Policy Information Center.
PUB DATE 1997-00-00
NOTE 71p.
PUB TYPE Numerical/Quantitative Data (110) -- Reports - Descriptive (141)
EDRS PRICE MF01/PC03 Plus Postage.
DESCRIPTORS Access to Information; Cable Television; *Computer Assisted Instruction; Computer Literacy; Computer Software Evaluation; Computer Uses in Education; Computers; Courseware; *Educational Assessment; *Educational Technology; *Elementary Secondary Education; Internet; Local Area Networks; Models; Optical Data Disks; Statistical Data; Teacher Competencies
IDENTIFIERS *Access to Technology; Computer Use; Connectivity; Multimedia Computer Systems; United States

ABSTRACT

The purpose of this report is to provide a "snapshot" of the status of technology use in United States schools. The report focuses on the following: school access to technology; student use of computers; evaluating the impact of educational technology; connecting teachers and technology; assessing the content and quality of courseware; and the costs of educational technology. Statistics for these issues are summarized and highlighted at the beginning of the report. Charted figures include: (1) technology penetration in U.S. public schools 1995-96; trends in the numbers of students per computer; the number of students per computer, multimedia computer, cable tv, internet access, CD-ROM, local area networks, videodiscs, and satellite technology compared to the number of Title I students, the number of minority students, and also compared by state; (2) students' use in 1994 of computers: at home and school, for school work, students with teachers teaching reading, U.S. history/social studies, and geography, use in mathematics, use by college-bound seniors, and computer-related coursework or experience of college-bound seniors by gender and race/ethnicity and in various subjects or experience; (3) percentage of teachers who had at least nine hours of training in education technology in 1994, by state; states requiring courses in educational technology for a teaching license, 1996; (4) courseware evaluation and application "road map"; number and percentage of courseware rated as "exemplary, desirable," and percentage not recommended by the CITC (California Instructional Technology Clearinghouse) from 1991 to 1995; for science, mathematics, history/social science, and English/language arts, 1995; integrating technology into the curriculum; (5) costs of four technology deployment models; ubiquitous LAN with local server and high-speed line model; average annual costs for fiber-optic broadband deployment to all U.S. public schools with three scenarios and two deployment schedules; and the percentage of schools in high-cost areas, by locality. (Contains 43 charts.) (AEF)

ED 412 893

Computers and Classrooms

The Status of Technology in U.S. Schools



"PERMISSION TO REPRODUCE THIS MATERIAL HAS BEEN GRANTED BY

R. Coley

TO THE EDUCATIONAL RESOURCES INFORMATION CENTER (ERIC)."

U.S. DEPARTMENT OF EDUCATION
Office of Educational Research and Improvement
EDUCATIONAL RESOURCES INFORMATION CENTER (ERIC)

- This document has been reproduced as received from the person or organization originating it.
- Minor changes have been made to improve reproduction quality.

• Points of view or opinions stated in this document do not necessarily represent official OERI position or policy.



POLICY INFORMATION CENTER

ERIC Educational Testing Service
Princeton, New Jersey 08541-0001

1R018357

CONTENTS

Preface	2
Acknowledgments	2
Summary and Highlights	3
Introduction	7
School Access to Technology	10
Computers	11
Multimedia Computers	13
Cable TV	15
Internet Access	17
CD-ROM	19
Networks	21
Videodisc	23
Satellite Technology	25
Student Use of Computer	27
School Computer Use Information from NAEP	27
Student Use of Computers at Home and School	27
Student Use of Computers for School Work	28
The Use of Computers in Teaching Reading, U.S. History/ Social Studies, and Geography	28
Student Use of Computers in Mathematics	29
Computer Coursework and Experience of College-Bound Seniors	30
A Profile of the Class of 1996	30
Change Over the Decade	32
Evaluating the Impact of Educational Technology	34
What the Research Shows	34
Evaluation Issues	38
An Example from the Field	38
Connecting Teachers and Technology	41
Current Status of Staff Development for Technology Use	41
Barriers to Effective Technology Use	43
Models for Connecting Teachers and Technology	44
Involving Administrators	46
Assessing the Content and Quality of Courseware	48
The Instructional Design of Courseware	49
The California Instructional Technology Clearinghouse	49
The CITC Evaluation Strategy	50
Guidance for Courseware Developers	52
The Quality of Current Courseware	52
Integrating Effective Courseware	54
Incentives for Research and Development	54
Next Steps	54
The Costs of Educational Technology	57
Estimating the Costs of Technology in Our Schools	57
Cost Models	58
California's Experience	62
Urban/Rural Cost Issues	62
Economies in Educational Technology Funding	63
Appendix	66

This report was written by:

Richard J. Coley
Policy Information Center
Educational Testing Service

John Cradler
Council of Chief State
School Officers

Penelope K. Engel
Educational Testing Service

The view expressed in this report are those of the authors and do not necessarily reflect the views of the officers and trustees of Educational Testing Service.

PREFACE

Education reform and the quality of schools top the list of national concerns these days. And the use of technology in classrooms shares top billing with the standards and assessment movement as ways to improve education.

This report is about technology in the classroom. It is not an argument for or against technology, nor a how-to-do-it manual. Its purpose is to inform — to bring together what we know about:

- the access of schools to technology and the fairness of access among students
- how technology is used in schools
- the effectiveness of educational technology
- issues involved in connecting teachers and technology
- the quality of educational courseware
- the costs of deploying technology in our schools

This report also provides a baseline of information from which we can track change. Change, of course, is the

one constant in the world of technology. This report is a “snapshot” of a rapidly changing phenomenon; the picture will have to be taken regularly for such information to be useful.

*Paul E. Barton
Director
Policy Information Center*

ACKNOWLEDGMENTS

The authors wish to thank the following people for their help with this report. At ETS, Tony Cline, Larry Frase, and Ellen Mandinach contributed advice early in the project and provided reviews of the report. Paul Barton and Howard Wainer of ETS, and Margaret E. Goertz of the Center for Policy Research in Education at the University of Pennsylvania also reviewed sections of the report.

Quality Education Data, Inc. provided pre-publication access to their data on technology penetration in schools and we are grateful to Laurie Christensen and Jeanne Hayes for their help. Ruth Mary Cradler of Educational Support Systems also provided assistance.

Shilpi Niyogi and Barbara Bruschi provided editorial support and Carla Cooper did the desk-top publishing. Rick Bruce, Rod Rudder, and Jim Wert designed the cover. Jim Chewing managed production.

Errors of fact or interpretation are those of the authors.

SUMMARY AND HIGHLIGHTS

SCHOOL ACCESS TO TECHNOLOGY

- There are major differences among schools in their access to different kinds of educational technology.
- Students attending poor and high-minority schools have less access to most types of technology than students attending other schools.
- Ninety-eight percent of all schools own computers. The current student-to-computer ratio of 10 to 1 represents an all-time low ratio. The ratio ranges from about 6 to 1 in Florida, Wyoming, Alaska, and North Dakota to 16 to 1 in Louisiana.
- While 85 percent of U.S. schools have multimedia computers, the average ratio of students to computers is 24 to 1, nearly five times the ratio recommended by the U.S. Department of Education. The ratio ranges from about 9 to 1 in Florida to about 63 to 1 in Louisiana. Students attending poor and high-minority schools have less access than students attending other schools.
- About three-quarters of the nation's schools have access to cable TV. This percentage ranges from 91 percent of Connecticut's schools to 36 percent of Vermont's schools. Students attending poor and high-minority schools have less access to cable TV than students attending other schools.
- Sixty-four percent of U.S. schools have access to the Internet, up from 35 percent in 1994 and 50 percent in 1995. In Delaware, Hawaii, New Mexico, and South Carolina, all schools are connected. Students attending poor and high-minority schools are less likely to have Internet access than other students. Only 14 percent of U.S. classrooms have access to the Internet.
- Little more than half of our schools have CD-ROM drives, ranging from 91 percent of the schools in North Carolina to only 29 percent of the schools in Vermont. Students attending poor and high-minority schools have less access to CD-ROM than students attending other schools.
- Thirty-eight percent of our schools are using local area networks (LANs) for student instruction. This ranges from 57 percent of the schools in Colorado, Utah, and

North Carolina, to 16 percent of the schools in Vermont. Students attending poor and high-minority schools have less access to LANs than students attending other schools.

- About one-third of U.S. schools have videodisc technology, ranging from 95 percent of Florida's schools to 10 percent of Mississippi's schools. Students attending poor and high-minority schools are more likely than students attending other schools to have access to videodisc technology.
- Just under one-fifth of our schools have access to satellite technology, ranging from 50 percent of the schools in Missouri to only 1 percent of Hawaii's schools. While students attending high-minority schools have less access to this technology than students attending other schools, students attending poor schools have more access than students attending rich schools.

USE OF COMPUTERS

- Among eleventh graders, writing stories and papers was the most frequently rated computer use at home and school. Among fourth and eighth graders, playing games (presumably at home) was the prevalent computer use. At all three grade levels, using the computer to learn things and for writing were highly rated uses. About half the students said they used a computer at home.
- Nine percent of fourth graders, 10 percent of eighth graders, and 19 percent of twelfth graders said they used a computer for school work almost daily. Sixty percent of fourth graders, 51 percent of eighth graders, and 37 percent of twelfth graders said that they never used a computer for school work.
- Black and Hispanic fourth graders were more likely than White and Asian students to report using computers almost daily.
- Fourth graders receiving Title 1 services and those attending the lowest scoring third of schools reported more frequent use of computers than other students.

- White, Black, and Hispanic twelfth graders were more likely than Asian students to report almost daily use of computers.
- Twelfth graders receiving Title I services and those attending rural/small town schools were more likely to report daily computer use than other students.
- About 40 percent of fourth-grade teachers used computers to teach reading, U.S. history/social studies, and geography.
- About one-third of eighth-grade teachers used computers to teach U.S. history/social studies and geography, and 17 percent reported using the computer to teach reading.
- With a few exceptions, the use of technology to teach reading, U. S. history/social studies, and geography was found to be equitable. Among the exceptions:
 - White fourth graders were more likely than Black fourth graders to have teachers who used computers to teach geography.
 - White eighth graders were more likely than their Black and Hispanic classmates to have teachers who used computers to teach history.
 - Students whose teachers indicated that the ability level of their class was low were less likely than other students to be taught geography using a computer.
- About half of the nation's 13- and 17-year-olds had access to a computer to learn mathematics.
- For college-bound seniors from the Class of 1996, word processing exposure was the most frequent type of coursework or experience, followed by computer literacy, use in English courses, use in solving mathematics problems, data processing, computer programming, and use in solving natural science and social science problems. Only 9 percent of students reported no computer coursework or experience. Findings by gender and racial/ethnic group follow:
 - Females were more likely than males to have word processing experience.
 - Students from minority groups were less likely to have courses or experience in word processing and computer literacy, and less likely to use computers in English courses and to solve problems in mathematics and natural science.
 - Minority group students were more likely to have courses in data processing and computer programming.
 - Females were less likely than males to have coursework or experience in computer literacy and computer programming, and less likely to use computers to solve math and natural science problems.
 - Since 1987, the percentage of college-bound seniors reporting no computer coursework or experience dropped from 26 percent to 9 percent.
 - Drops were registered in computer programming and in using the computer to solve math problems.
 - Increases were registered in all other areas, particularly in word processing and in using computers in English courses.

THE EFFECTIVENESS OF EDUCATIONAL TECHNOLOGY

- Research generally agrees that drill-and-practice forms of computer-assisted instruction are effective in producing achievement gains in students.
- More pedagogically complex uses of educational technology generally show more inconclusive results, yet many offer promising and inviting educational vignettes.
- Many ongoing educational technology projects are in the process of documenting and recording measures of student motivation, academic outcomes, and other outcomes such as increased skills in problem-solving and collaboration.

- Evaluations of educational technology are really evaluations of instruction enabled by technology, and the outcomes are highly dependent on the implementation of the instructional design.
- Evaluations of educational technology applications must confront a number of methodological problems, including the need for measures other than standardized achievement tests, differences among students in opportunity to learn, and differences in starting points and program implementation.
- Effects of educational technology on teachers should be emphasized because teachers remain in the classroom to influence many generations of students.

CONNECTING TEACHERS AND TECHNOLOGY

- Research shows that helping teachers learn how to integrate technology into the curriculum is a critical factor for the successful implementation of technology applications in schools.
- Most teachers have not had the education or training to use technology effectively in their teaching.
- Only 15 percent of U.S. teachers reported having at least nine hours of training in education technology in 1994.
- In 18 states, teacher education students do not need courses in educational technology to obtain a teaching license.
- Only 16 percent of teachers currently use telecommunications for professional development.
- Research on the adoption of innovations in schools consistently points to the key role of administrators in successful implementation.
- Effective staff development for teachers should take advantage of telecommunications technologies that allow teachers to interact with each other, take online courses, and easily access the latest research in their discipline.

EFFECTIVE COURSEWARE

- Effective courseware needs to reflect the research on how students learn, be matched to national, state, or district educational standards, and be integrated into the teaching and learning activities of the classroom.
- Research-based criteria for the development of effective curriculum should also be applied to the development and selection of educational courseware.
- The California Instructional Technology Clearinghouse has rated only 6 to 8 percent of evaluated courseware as “exemplary,” and from 33 to 47 percent as “desirable.” Less than half of the courseware submitted to the Clearinghouse had sufficient quality to merit review.
- Promising directions in courseware development might include a national clearinghouse; partnerships among developers, teacher groups, and private and public agencies; and a determination of courseware needs that would meet current and emerging curriculum directions.

THE COSTS OF EDUCATIONAL TECHNOLOGY

- Research shows that the cost of the technology currently in our schools is about \$3 billion, or \$70 per pupil. This cost represents just over 1 percent of total education spending.
- Estimates indicate that it will cost about \$15 billion to make all of our schools “technology rich.” This is about \$300 per student, 5 percent of total education spending, and about five times what we now spend on technology.
- Different deployment scenarios are estimated to cost from \$11 billion for a lab with 25 networked PCs in every school, to \$47 billion for a networked PC for every five students.
- The primary upfront factor affecting costs is the purchase and installation of computers and other hardware.

- Secondary, very high-cost, factors relate to the hiring or reassignment of technology staff and the training of staff and teachers.
- Telecommunications costs (e.g., Internet access, telephone bills) are a small portion of total technology costs, estimated at from 4 to 11 percent.
- Connecting schools with cable substantially increases their technological capacity over that of telephone wire, but technical problems have to be solved.
- Wireless solutions are appropriate and cost-effective under certain circumstances, such as in old buildings requiring asbestos removal or in rural areas. Savings from 20 to 40 percent of the cost of Internet connectivity have been observed.
- Urban/rural disparities in telephone costs exist which adversely affect rural schools. Significantly higher percentages of non-metropolitan than metropolitan schools are located in high-cost service areas.
- A variety of technology cost reductions to schools have been achieved through the configuration of networks, discounted group rates, donated services, and special programs.

INTRODUCTION

I believe that the motion picture is destined to revolutionize our educational system and that in a few years it will supplant largely, if not entirely, the use of textbooks...

Thomas Edison, 1922

Because education will be much more efficient, it will probably cost less than it does now. This is not a utopian dream. It is well within the range of an existing technology of teaching.

B.F. Skinner, 1986

There won't be schools in the future... I think the computer will blow up the school. That is, the school defined as something where there are classes, teachers running exams, people structured in groups by age, following a curriculum — all of that...

Seymour Papert, 1984¹

Education has always been susceptible to “silver bullet” solutions to its problems, and imposing a new technology has often been such a solution. Yet time after time, the “technology du jour” has collided with the realities of the classroom and resulted in only marginal changes in how teachers teach and students learn. Why is this so? And what are the prospects for change?

Some researchers point out that “techno-reformers” too often ignore the main purpose of schooling, the real social organization of schools, and the pressing daily realities of teaching. Teachers are seen as part of the problem and are burdened with solving it.² Yet most of the teachers in today’s classrooms have had little training or experience in technology. Nationally, only 15 percent of our teachers had at least nine hours of

training in educational technology in 1994; and as of 1996, 18 of the states did not require courses in educational technology for a teaching license.³ Further, teachers often have difficulty linking educational technology use to local curricula and integrating it with instruction and assessment.

Perhaps another problem is the coupling of educational technology issues with education reform issues. Some computer advocates argue that computers will become integrated in our schools only when teachers teach differently than they do now and students study a different curriculum. Others have suggested that we can make headway in getting teachers to use computers in instruction if we stop trying to get teachers to do their jobs differently and begin

using technology to help teachers do their jobs as they do them now. Once the use of computers is unhitched from movements to reform teaching and redesign the curriculum, technology stands a better chance of assuming an important educational role.⁴

We need to remember at least two important things. First, computers in and of themselves do very little to aid learning. The presence of technology in the classroom does not automatically inspire teachers to rethink their teaching or students to adopt new modes of learning. Although computers may make the work more efficient and more fun, students’ use of computers for various tasks — like writing, drawing, or graphing — does not tend to radically change what they would have done without computers. Computer technology

may provide powerful learning opportunities, but both teachers and students need to learn how to take advantage of them. Second, no single task or activity has profound and lasting effects on learning by itself. Rather, it is the whole culture of a classroom environment that can have important effects on learning.⁵

What is educational technology? And how is it used in schools today? In the broad sense, the term includes any resources used in the education of students. These can include methods, tools, or processes. In practice, the term was used in the post World War II era to mean technologies such as film strips, slide projectors, language laboratories, audio tapes, and television. Since the advent of personal computing in the 1980s, the phrase has come to refer

Some Milestones in Educational Technology

Although today's technology reform started about 15 years ago, technology in the schools goes back twice as far. The computer-assisted instruction projects of the 1960s evolved, with the increased availability of personal computers, into the CD ROM-based multimedia learning resources of today. At the same time, telecommunications networks burgeoned, greatly extending the possibility of connections to learning sources across time and space, via voicemail, E-mail, direct broadcast via satellite, and the electronic resources of the World Wide Web.

The federal government supported technology for schools as early as the late 1950s, largely through funding from the National Science Foundation and the Department of Education. More recently the departments of Agriculture, Commerce, Defense, and Energy, as well as NASA and the National Endowment for the Humanities, have offered funds for educational technology. These federal efforts have supported educational television programming and facilities, development of computer-based instructional materials, hardware and software purchases, demonstration projects, educational technology centers, distance learning networks, conferences, evaluations, assistive technologies for disabled learners, and more recently, support for telecommunications networks and educational technology planning.⁷

Federal legislation passed in 1994, both The Goals 2000:

Educate America Act and the Improving America's Schools Act (IASA), authorized funds for state and federal educational technology planning. Five million dollars have now been distributed under Goals 2000 to nearly all 50 states for development of state technology task forces and plans. IASA has supported federal leadership, regional technology centers, and 43 large technology challenge grants to school-business-college partnerships for technology to improve learning. It also authorized America's Technology Literacy Challenge, for which \$200 million were appropriated for FY 1997. Title I of IASA provided some \$450 million, and Title VI some \$60 million, for support of educational technology in FY 1996.

President Clinton and Vice President Gore have made educational technology a high visibility, high priority issue. In 1996 Clinton called for connecting every classroom in America to the information superhighway, "with computers and good software and well-trained teachers." The White House announced four educational technology goals:

- 1. All teachers in the nation will have the training and support they need to help students learn using computers and the information superhighway.*
- 2. All teachers and students will have modern multi-*

media computers in their classrooms.

- 3. Every classroom will be connected to the information superhighway.*

- 4. Effective software and on-line learning resources will be an integral part of every school's curriculum.*

Other White House technology initiatives include America's Technology Literacy Challenge, a five-year effort to help states achieve the goals; a 21st Century Teachers program to recruit teachers to train others in technology use; and the "Tech Corps" which involves volunteers helping schools integrate technology into the classroom.

A National Education Summit of governors and business, education, and community leaders, convened in Palisades, New York in March 1996, also stressed the importance of educational technology. Conference leaders committed to helping educators overcome barriers, including "planning for the acquisition and integration of technology in schools, the high cost of acquiring and maintaining technology, the lack of school technology policies, resistance to change, and the need for staff development and curriculum change."⁸ The participants pledged to subject their states to public scrutiny through annual report cards on their progress.

The Federal Communications Commission (FCC), under the direction of Chairman Reed Hundt, has been playing an important role in making telecommunications services accessible to schools, including enabling schools to create wireless computer networks, allowing inexpensive access to the Internet and other advanced telecommunications services. As this report goes to press, the FCC is developing provisions to meet the Telecommunications Act of 1996, which requires that affordable service and access to advanced telecommunications services are provided to public schools and libraries, including higher discounts for economically disadvantaged schools and those located in high-cost areas. A final FCC decision is expected in May 1997.

The President has continued his support for educational technology in 1997 by recommending in his State of the Union address and budget request a doubling of the funding for America's Technology Literacy Challenge. For FY 1998, \$425 million was requested as the second installment of a five-year, \$2 billion investment to modernize schools to prepare students for work in the coming century.

primarily to computer-based learning, and most recently to learning environments established with computer and communications technologies. In short, educational technology is a phrase used to refer to the most advanced technologies available for teaching and learning in a particular era.⁶

How are educational technologies being used in today's classrooms? At one end of the spectrum, computers are used to "deliver" traditional instruction, e.g., software provides drill-and-practice in multiplication tables. In other instances, computers provide students with experience in technologies that adults use in many work situations — word processors for writing, data bases for collecting and analyzing information, and desktop publishing software for publishing. Computers are increasingly being used to provide students with opportunities to explore "microworlds," enabling them to "construct" new knowledge and learn basic skills in useful contexts. Finally, Internet connections allowing electronic mail, file transfer, conferencing, and access to remote

expertise and information offer tantalizing promise to educators seeking to prepare students for the 21st century.

In assessing the status of educational technology in our schools, equity issues are paramount. Some reformers argue that technology can be the "one" educational change that can really make a difference for disadvantaged students, allowing them to transcend the boundaries of their schools. Others warn that technology could widen the gap between the education "haves" and "have nots." Where available, data in this report are broken out by demographic categories to help determine which way we are heading.

While many educational technology issues continue to be debated, the presence of technology in schools continually expands. This expansion will continue, whether one believes that computers should be an integral part of education for pedagogical reasons, or that their use is justified simply because of the technical requirements of the world in which today's

students will work. Meanwhile, those concerned about these issues — the public, teachers, educational technology planners, and policymakers at the federal, state, district, and school level need current information about how technology is being used in classrooms today and what are its effects.

This report attempts to meet that demand for information. The aim is to provide a "snapshot" of where the U.S. is in terms of technology in classrooms. We assemble data to answer the following questions:

- How much technology is in our schools and is it allocated fairly?
- How are computers used in schools? Is access equitable?
- What do we know about the effectiveness of educational technology and what are the evaluation problems we face?
- How can teachers and technology be better connected?
- What is the quality of current educational courseware and how is it related to current educational standards?

- What are the costs of deploying technology in our schools?

1 Quotations from Nira Hativa and Alan Lesgold, "Situational Effects in Classroom Technology Implementations: Unfulfilled Expectations and Unexpected Outcomes," in Stephen T. Kerr (ed.), *Technology and the Future of Schooling*, Chicago: University of Chicago Press, 1996.

2 Larry Cuban, "Revolutions that Fizzled," *Washington Post Education Review*, October 27, 1996.

3 Education Week, *Quality Counts: A Report Card on the Condition of Public Education in the 50 States*, January 22, 1997.

4 Tom Loveless, "Why Aren't Computers Used More in Schools?" *Educational Policy*, Volume 10, Number 4, December 1996.

5 Gavriel Salomon and David Perkins, "Learning in Wonderland: What Do Computers Really Offer Education?" in Stephen T. Kerr (ed.), *Technology and the Future of Schooling*, Chicago: University of Chicago Press, 1996.

6 Roy Pea, "Learning and Teaching with Educational Technologies," in H.J. Walberg & G.D. Haertel (eds.), *Educational Psychology: Effective Practices and Policies*, Berkeley, CA: McCutchan Publishers, 1996.

7 Office of Technology Assessment, *Power On! New Tools for Teaching and Learning*, Washington, DC: 1988.

8 National Education Summit, "1996 National Education Summit Policy Statement," Sponsored by the IBM Corporation, the National Governors Association, and the Education Commission of the States, Palisades, New York, March 27, 1996.

School Access to Technology

Two of the four *Technology Literacy Challenge* goals are related to the presence of hardware in our schools:

- *All teachers and students will have modern multi-media computers in their classrooms.*
- *Every classroom will be connected to the information superhighway.*

Computers are becoming ubiquitous in today's elementary and secondary schools — 98 percent of schools report owning a computer.¹ But do all students have equal access to technology? This section of the report examines the presence of various types of technologies in schools in the 1995-1996 school year and focuses on whether different types of students, or students in different types of schools, have different access to these technologies.

This analysis includes gauging the access to technology of students receiving Title 1 services (a federal program for our most economically disadvantaged students) and for minority students (students who are of African-, Asian-, Hispanic-, or Native-American origin).² In addition, we show the variation

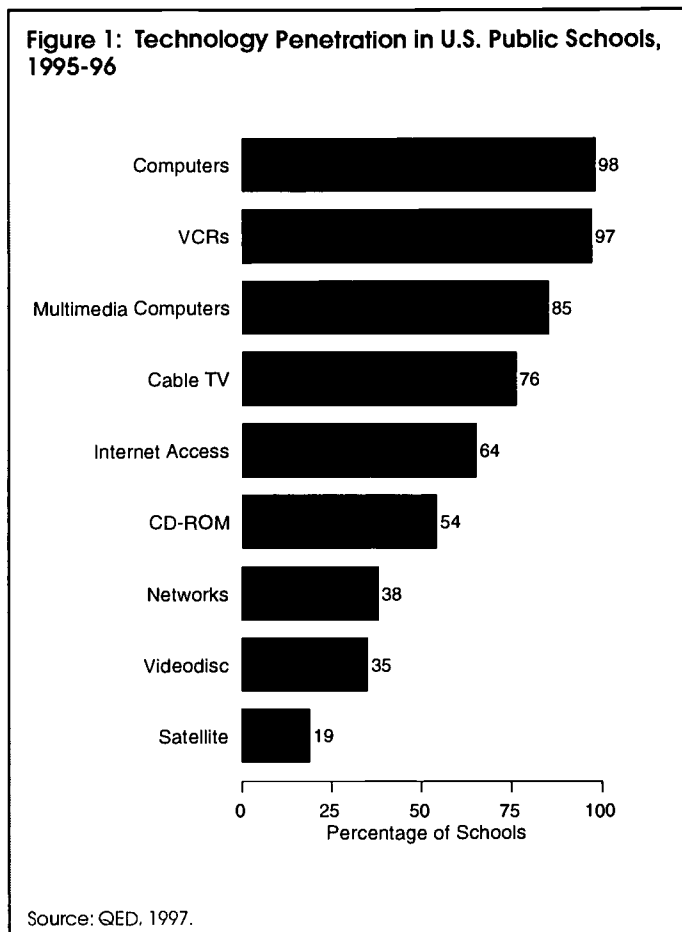

that exists across the 50 states.

Figure 1 shows an overall picture of technology penetration in U.S. public schools in the 1995-96 school year. Nearly all schools have computers and video cassette recorders (VCRs), and three-quarters or more of all U.S. schools own multimedia computers and cable television. Sixty-four percent of schools have Internet connections. About half own CD-ROM drives and approximately one-third

are equipped with local area networks (LANs) and videodisc players. About one-fifth of schools use satellite technology. Each of these technologies is discussed in the following sections.

COMPUTERS

There are 4.4 million computers in America's classrooms, with the typical school owning between 21 and 50. The Apple platform still leads in K-12 computing with a share of 60 percent (41 percent Macintosh and 19 percent Apple II and IIGS). DOS machines have 40 percent of the market.

As shown in Figure 2, the ratio of students to computers has declined from 125 students per computer in 1984 to the current ratio of 10 students per computer, the all-time low.

The ratio of students to computers decreases as the grade level increases. Elementary schools have a ratio of 11 to 1; middle/junior highs have a ratio of 9.7 to one; and senior highs have a ratio of 8.4 to 1. The rate of computer growth has slowed as districts and schools have invested in network and telecommunication technology. Modernization also has had an effect as older equipment is retired and replaced.

Technology penetration can also be examined by the amount of discretionary dollars a district spends per student. Discretionary dollars are dollars spent for instruction less salaries

and fringe benefits. As expected, high-spending districts (\$500 or more per pupil) have more computers per student, on average, than other districts. High-spending districts have an average of 9.7 students per computer, compared to 10.2 students per computer for medium-spending districts, and 10.6 students per computer for low-spending districts.

What about the relationship between the availability of computers and student need? The data show that students with the most need get the least access. As seen in Figure 3, the ratio of students to computers goes up as the percentage of Title 1 students increases. Thus, students in schools with the largest percentage of economically disadvantaged students have the highest ratio. Additionally, as seen in Figure 4, schools with large proportions of minority students also have the highest ratios. While schools with less than 25 percent of such students have a student-to-computer ratio of about 10 to one, students in schools with 90 percent or more of minority students have a ratio of 17.4 to one.

Figure 2: Trends in the Number of Students per Computer

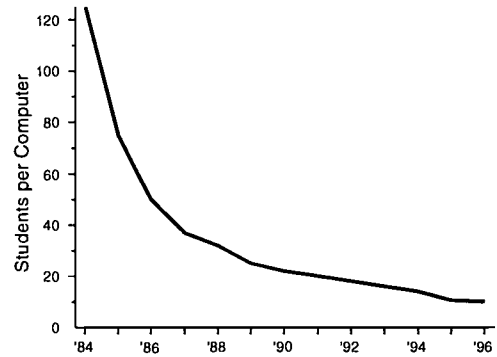

Source: QED, 1997.

Figure 3: Relationship between the Number of Students per Computer and the Percentage of Title 1 Students

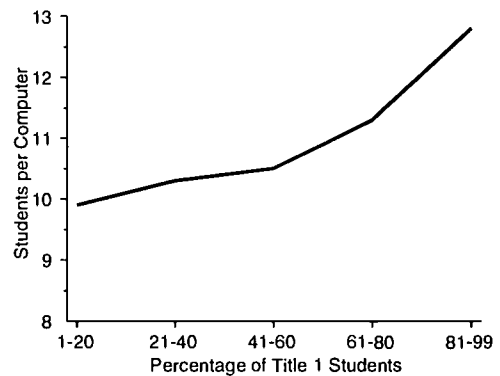

Source: QED, 1997.

Figure 4: Relationship between the Number of Students per Computer and the Percentage of Minority Students

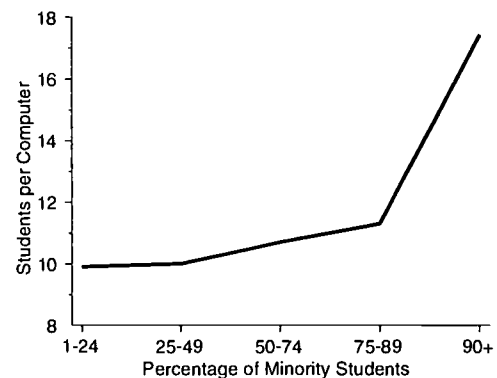

Source: QED, 1997.

Figure 5: Number of Students per Computer, by State

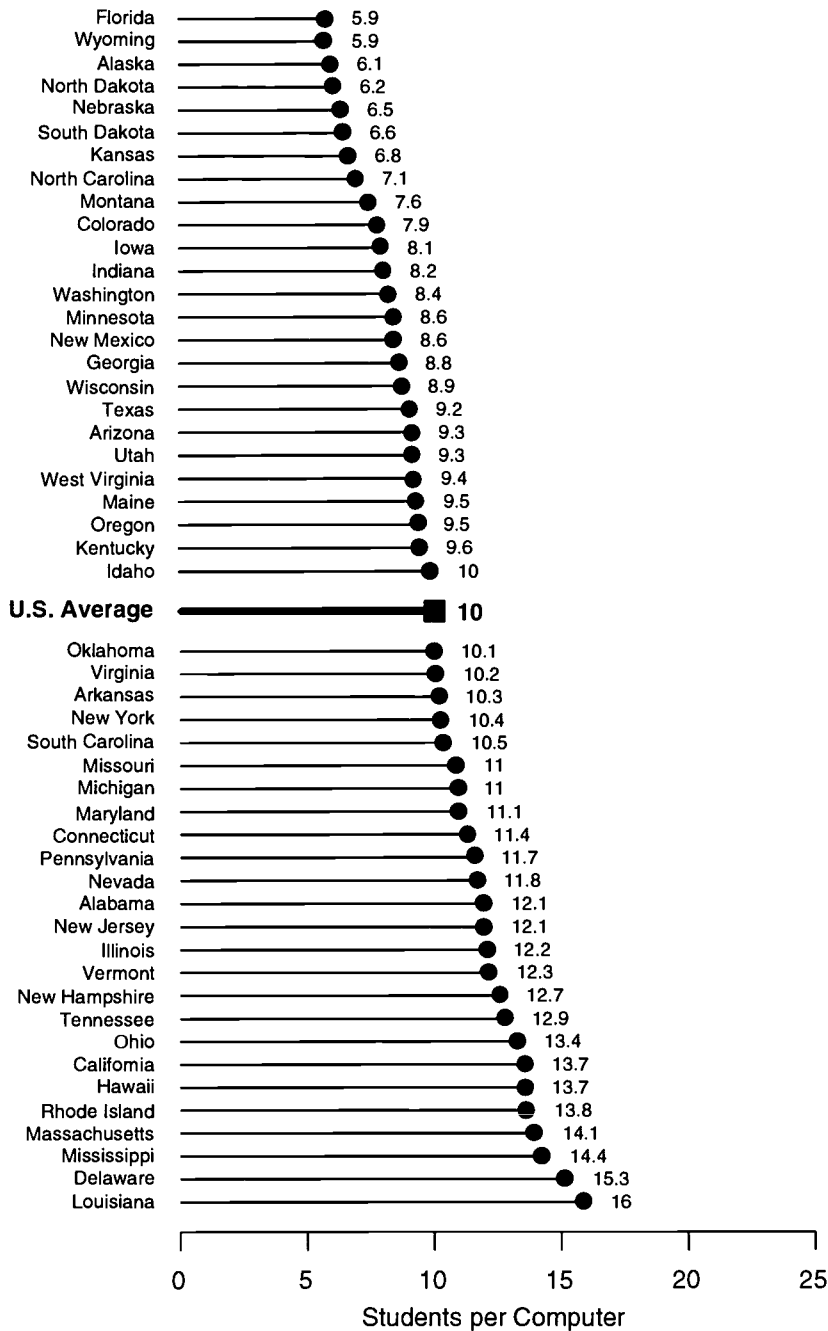

Source: QED, 1997.

This pattern of inequity is persistent in the data that will follow. Previous analyses have shown a positive relationship between the percentage of Title 1 students and computer availability.³ The general trend was more technology in poorer schools. This no longer appears to be the case. While Title 1 funding is designed to help poor schools, these targeted resources are apparently ineffective in getting these schools up to par technologically with other schools. Since much of the technology that currently resides in poor schools is probably due to Title 1 funds, it is hard to imagine what the technology level in these schools would be like without this federal program.

Figure 5 shows the student-to-computer ratio for each state. While state averages can mask differences that exist among a state's school districts, averages can be useful in recognizing the differences that exist among the states. Florida, Wyoming, Alaska, North Dakota, Nebraska, South Dakota, and Kansas lead the states with about six students per computer, on average. At the other end, Massachusetts, Mississippi, Delaware, and Louisiana have student-to-computer ratios of 14 to one or more.

MULTIMEDIA COMPUTERS

Multimedia systems include high-speed computers with large memory and storage capacities that are augmented with various components and peripherals that provide sound, graphics, and video. Multimedia computers are important in taking advantage of learning opportunities provided by the Internet and the World Wide Web. While 85 percent of the nation's schools have some multimedia computers, in the average school the ratio of students to multimedia computers is about 24 to one. According to the U.S. Department of Education, the optimum ratio is five to one, nearly five times less than the current national ratio.⁴

High-spending districts generally provide students with better access to multimedia computers. The ratio in low-spending districts is almost 29 to one, compared to a ratio of 23 to one in high-spending districts.

Students attending schools with large concentrations of poor and minority students have more limited access to multimedia computers

than other students. Figures 6 and 7 show the dimensions of this problem.

The figures show consistent differences in the student-to-multimedia computer ratio in schools educating large proportions of Title 1 and minority students. As shown in Figure 6, as the percentage of Title 1 students goes up, so does the ratio of students to computers. Schools where less than 20 percent of the students qualify for Title 1 have a ratio of about 22 students per computer, compared to a ratio of about 32 students per computer in schools where 81 percent or more of the students are eligible for Title 1.

Schools with more than 50 percent of minority students have higher student-to-multimedia computer ratios than other schools. As can be seen in Figure 7, most striking is that in schools with 90 percent or more minority students, the ratio is about 30 students per computer, compared to a ratio of about 22 to one for schools with between 25 and 49 percent of minority students.

The ratios by state are shown in Figure 8. Differences across states

Figure 6: Relationship between the Number of Students per Multimedia Computer and the Percentage of Title 1 Students

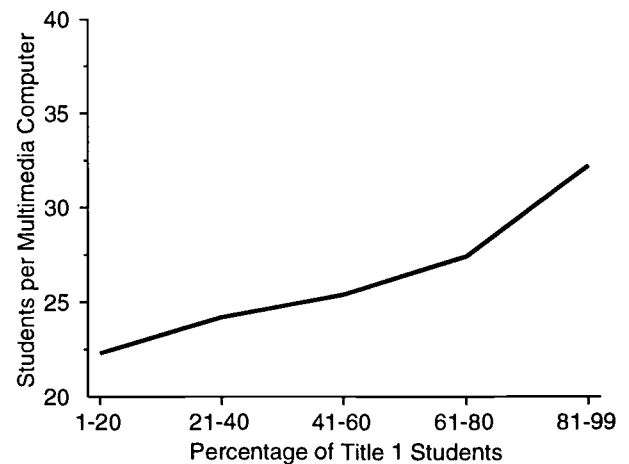

Source: QED, 1997.

Figure 7: Relationship between the Number of Students per Multimedia Computer and the Percentage of Minority Students

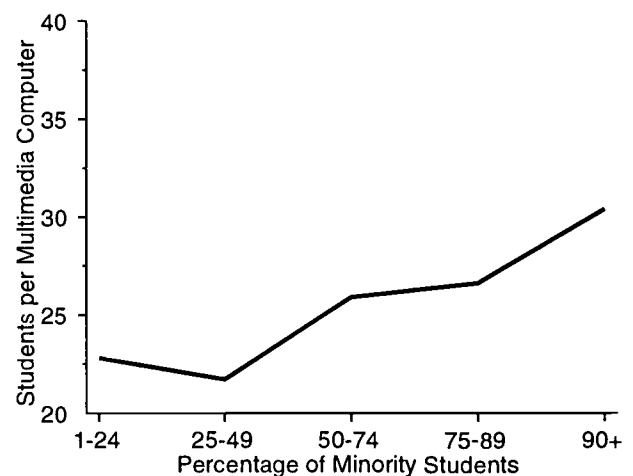

Source: QED, 1997.

Figure 8: Number of Students per Multimedia Computer, by State

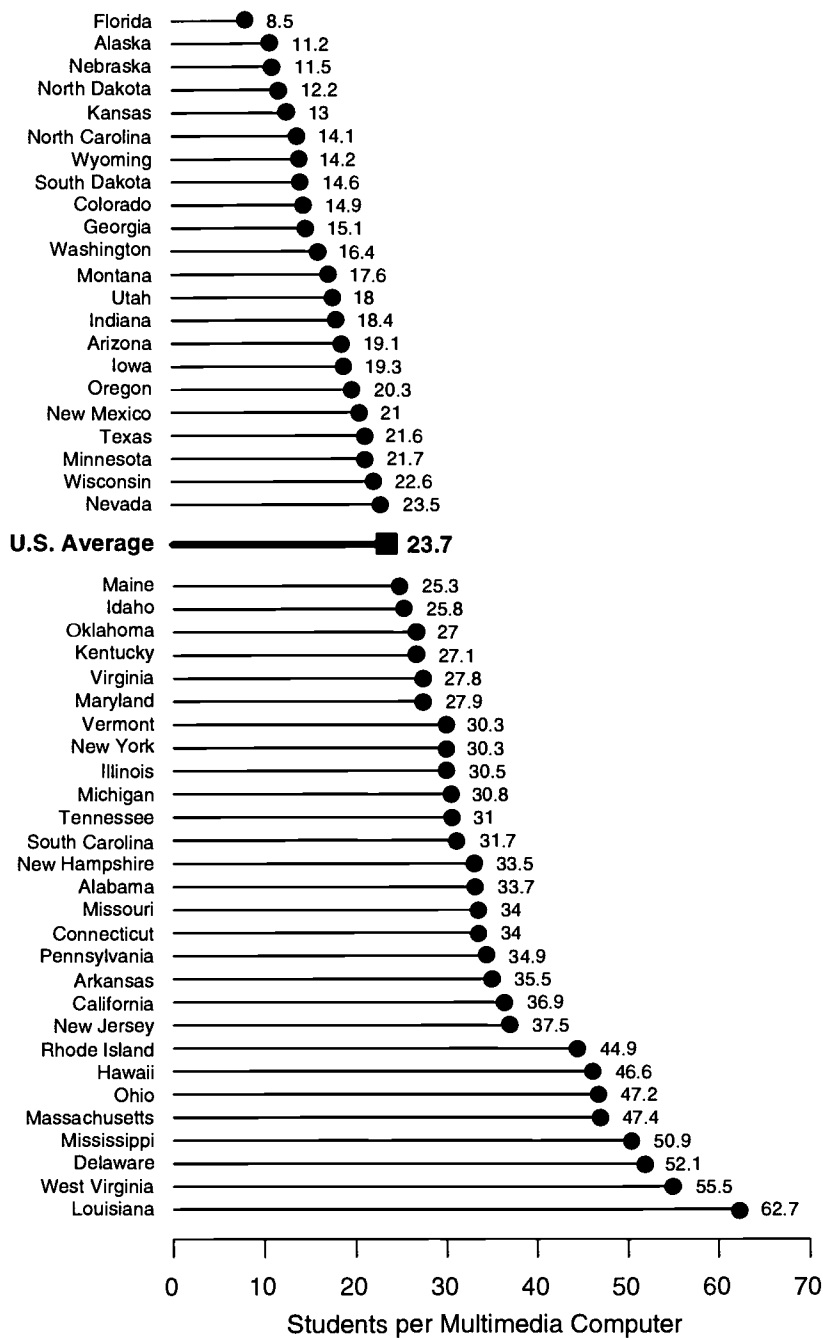

are large. Florida leads all states with a ratio of students to multimedia computers of 8.5 to one, compared to ratios of more than 50 to one in Mississippi, Delaware, West Virginia, and Louisiana.

Source: QED, 1997.

CABLE TV

Cable television has been used as an instructional tool due to its availability, price, and programming options. Educational channels such as the Learning Channel and the Discovery Channel, as well as off-hour programming which can be pre-recorded make cable a valuable instructional supplement for a variety of school subjects.

Ninety-four percent of the nation's students are enrolled in school districts where cable TV is used in at least one district building. Currently, 76 percent of our schools have cable TV, up 31 percent over the last four years.

District size is a strong predictor of cable use. As with most educational technologies, the use of cable TV increases with district size, reaching 99 percent of the school districts with 25,000 or more students. Only among districts with fewer than 1,000 students does cable usage fall, reaching only 55 percent. These small districts are likely to be located in rural areas where cable access may not be available.

There is also a higher likelihood that more advantaged schools will have cable TV available. As shown in Figure 9, the availability of cable was lower in poor schools than in average and rich schools. In addition, schools with low percentages of minority students were more likely to have cable TV than other schools (Figure 10).

State rankings on school access to cable TV are shown in Figure 11. Cable TV appears to be prevalent in most states' schools. Alaska and Vermont appear to be exceptions.

Figure 9: Relationship between the Percentage of Schools with Cable TV and the Percentage of Title 1 Students

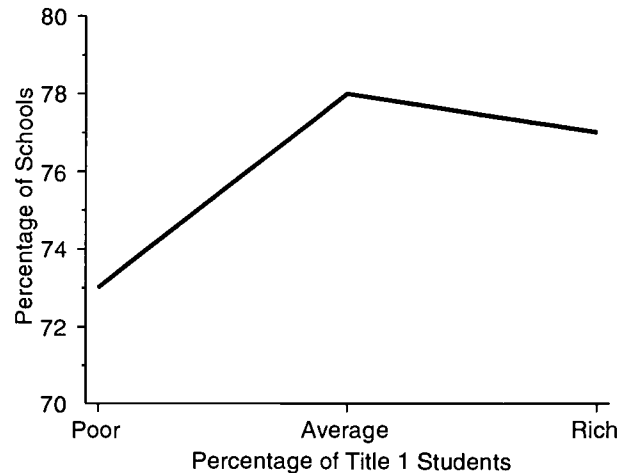

Source: QED, 1997.

Figure 10: Relationship between the Percentage of Schools with Cable TV and the Percentage of Minority Students

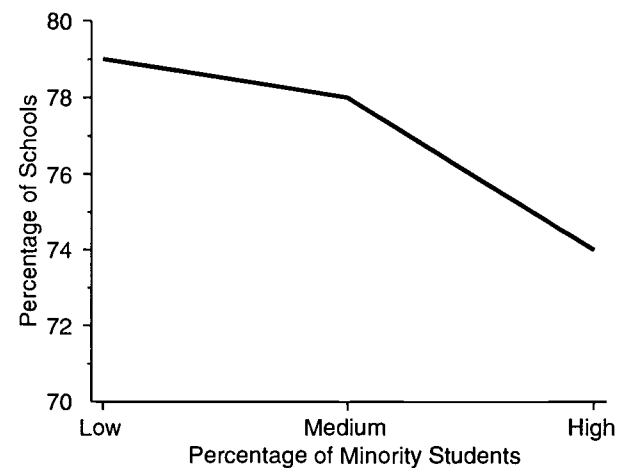

Source: QED, 1997.

Figure 11: Percentage of Schools with Cable TV, by State

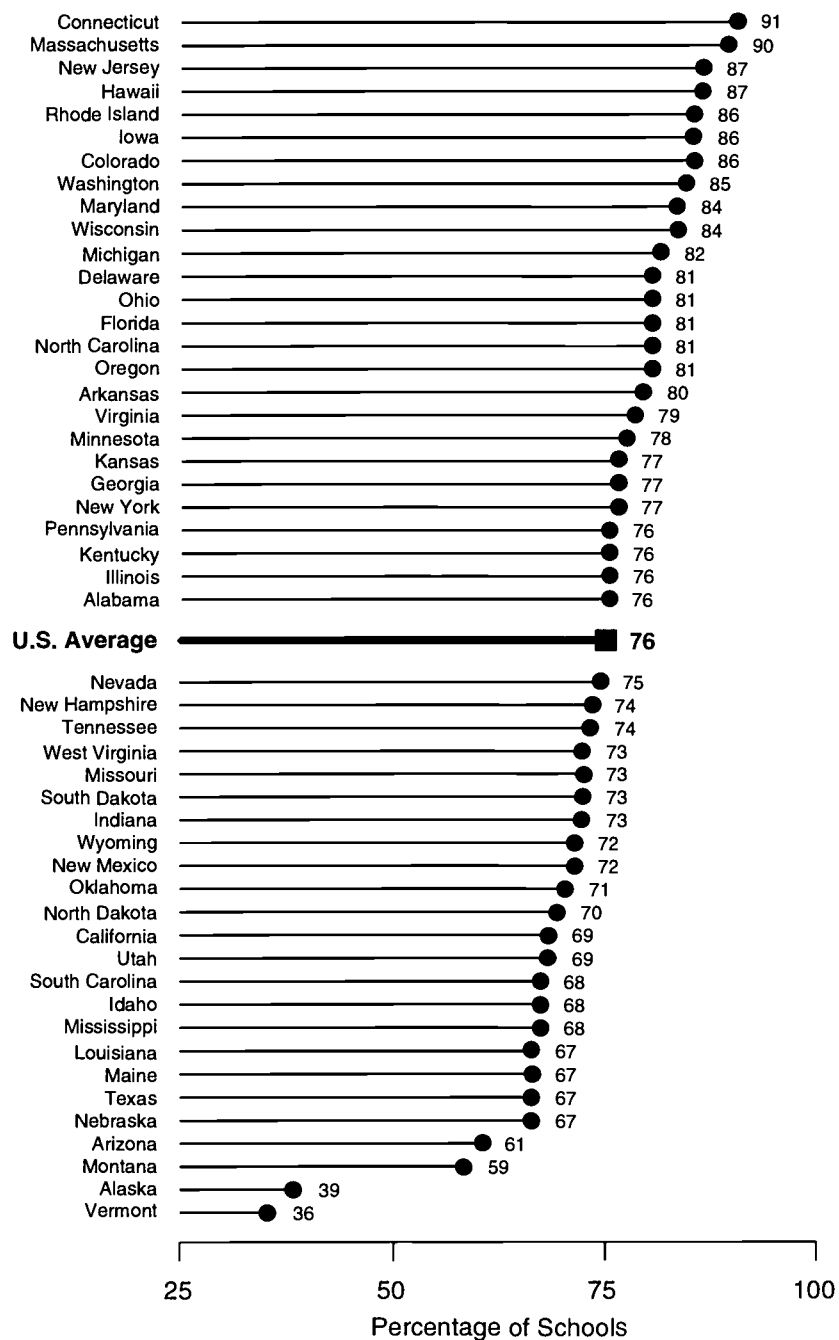

Source: QED, 1997.

INTERNET ACCESS⁵

The availability of Internet access allows students and teachers to communicate with other students and teachers and to expand their use of teaching and learning resources. Nearly all of the states have created some form of educational network for teachers, administrators, and students.

Sixty-four percent of U.S. schools had Internet access in the Fall of 1996, a gain of 15 percentage points in each of the last two consecutive years. Large schools were more likely to have access than small schools, and secondary schools were more likely to have Internet access than elementary schools.

Only 14 percent of all public school instructional rooms (classrooms, computer or other labs, and library media centers), however, had Internet access. This is more than a four-fold increase since the fall of 1994, when only 3 percent of all instructional rooms had Internet access.

Data on Internet access reveal disadvantages for schools enrolling large proportions of poor and minority students. Figure 12

shows the percentage of schools with Internet access broken out by the percentage of poor students in those schools. While about three-quarters of schools with smaller percentages of poor students have Internet access, the percentage drops to slightly more than half of schools with high levels of poor students.

Figure 13 shows the percentage of schools with Internet access broken out by the proportion of a school's minority students. A similar trend line occurs — the higher the proportion of minority students within a school, the less likely it is to have access to the Internet.

Internet access by state is shown in Figure 14. While all schools in Delaware, Hawaii, New Mexico, and South Carolina have Internet access, one in five or less of the schools in Ohio, California, Illinois, Oklahoma, and Texas have access.

Figure 12: Relationship between the Percentage of Schools with Internet Access and the Percentage of Poor Students

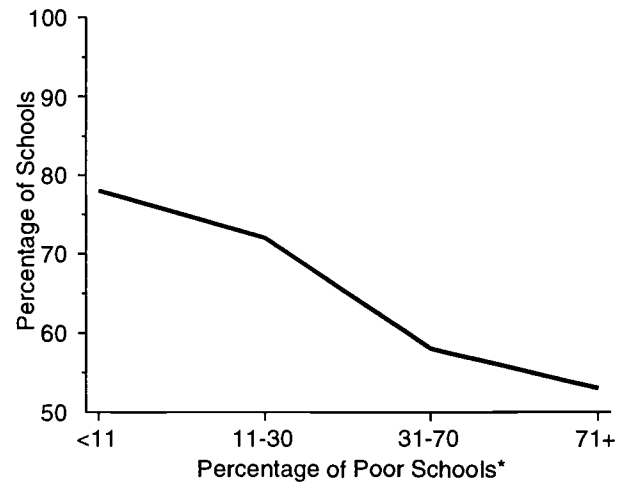

Source: National Center for Education Statistics, *Advanced Telecommunications in U.S. Public Elementary and Secondary Schools, Fall 1996* February 1997.

*NCES defines poor as eligible for free or reduced-price school lunch.

Figure 13: Relationship between the Percentage of Schools with Internet Access and the Percentage of Minority Students

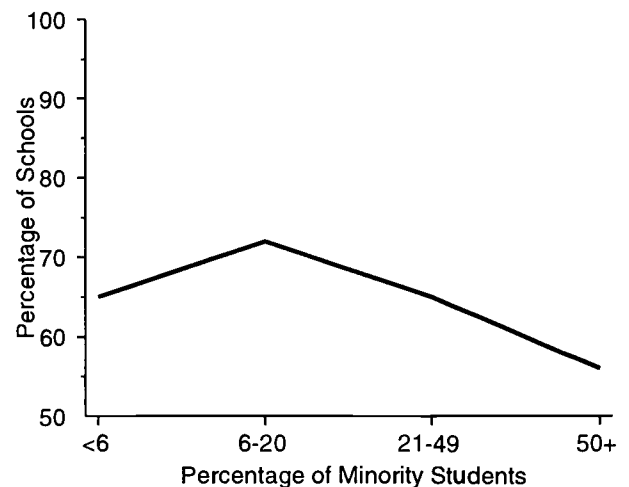

Source: National Center for Education Statistics, *Advanced Telecommunications in U.S. Public Elementary and Secondary Schools, Fall 1996* February 1997.

Figure 14: Percentage of Schools with Internet Access, by State

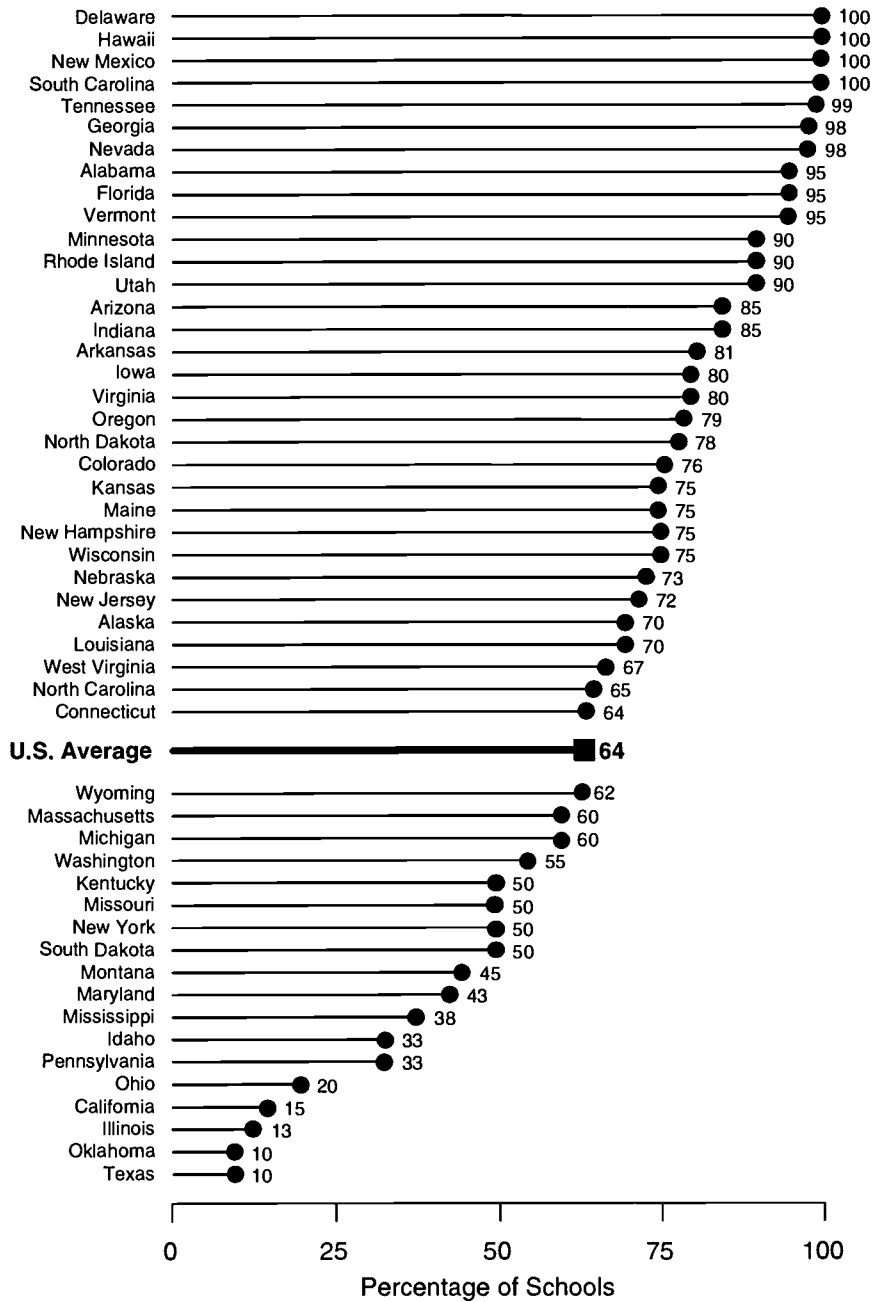

Source: QED, 1997.

CD-ROM

CD-ROM is the fastest growing educational technology. This growth has been spurred by the increasing availability of multimedia computers and the decreasing cost of software available on CD-ROM. Fifty-four percent of the nation's schools now have this technology.

CD-ROM ownership is related to enrollment, although the difference is getting smaller. The larger the school district, the more likely it is to be using a CD-ROM drive for student instruction in at least one of its schools.

Poor schools are less likely than rich or average schools to have CD-ROM technology. These data are shown in Figure 15. The relationship between CD-ROM ownership and the percentage of minority students in a school is shown in Figure 16. In general, the more diverse a school's student population, the less likely it is to own a CD-ROM.

Figure 17 shows the variation in school CD-ROM ownership across the states. North Carolina appears at the top of the chart, with 91 percent of its schools owning this technology. Fewer than one-third of Hawaii's and Vermont's schools, on the other hand, own a CD-ROM.

Figure 15: Relationship between the Percentage of Schools with CD-ROM and the Percentage of Title 1 Students

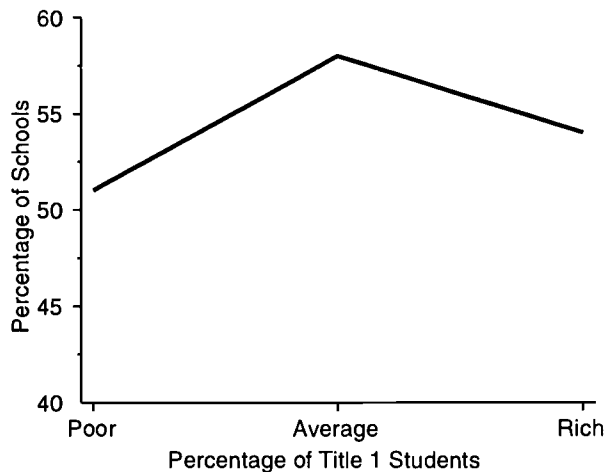

Source: QED, 1997.

Figure 16: Relationship between the Percentage of Schools with CD-ROM and the Percentage of Minority Students

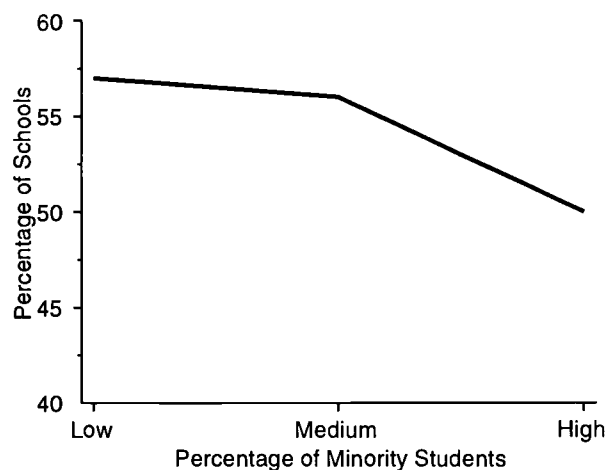

Source: QED, 1997.

Figure 17: Percentage of Schools with CD-ROM, by State

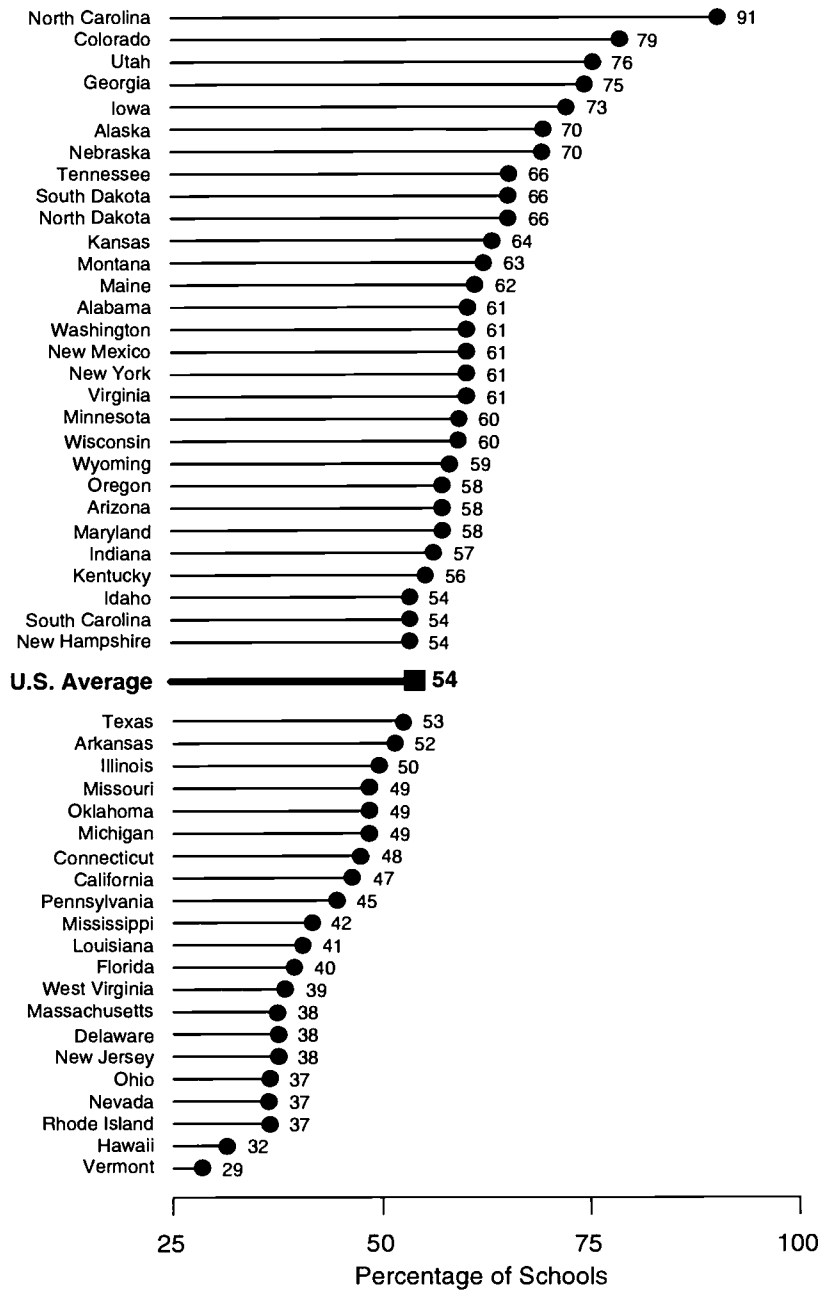

Source: QED, 1997.

BEST COPY AVAILABLE

NETWORKS

While Local Area Network (LAN) technology has been available for many years, districts have only recently begun implementing networks in their schools. Districts use networks to connect multiple computers to share information and resources. Thirty-eight percent of the nation's schools are using networks for student instruction.

Large districts and large schools are the most likely to use networks. In addition, network ownership rates increase with grade level — 56 percent of senior high schools use networks, compared to 43 percent of middle/junior high schools, and 31 percent of elementary schools.

Poor schools are less likely than average and rich schools to use networks. These data are shown in Figure 18. Figure 19 shows the relationship between networks and the percentage of minority students. As shown, schools with high percentages of minority students have less access to LAN technologies than other schools.

Figure 20 shows variation across the states. While 57 percent of the schools in Colorado, Utah,

and North Carolina have LAN access, the percentage drops to one-quarter or less of the schools in Louisiana, Delaware, Massachusetts, Hawaii, and Vermont.

Figure 18: Relationship between the Percentage of Schools with Local Area Networks and the Percentage of Title 1 Students

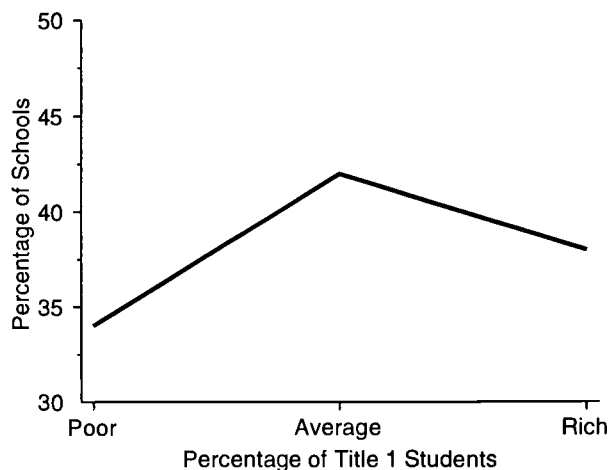

Source: QED, 1997.

Figure 19: Relationship between the Percentage of Schools with Local Area Networks and the Percentage of Minority Students

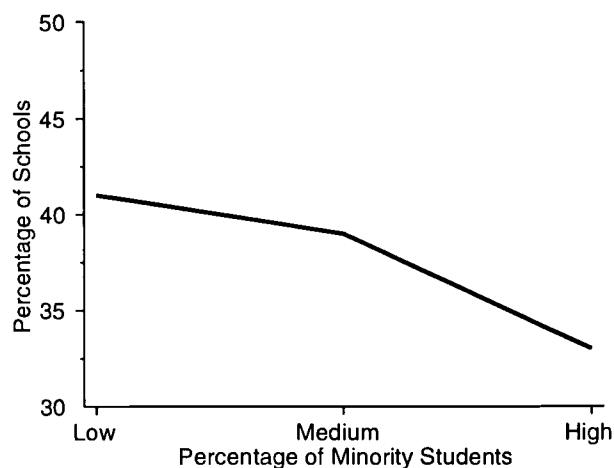

Source: QED, 1997.

Figure 20: Percentage of Schools with Local Area Networks, by State

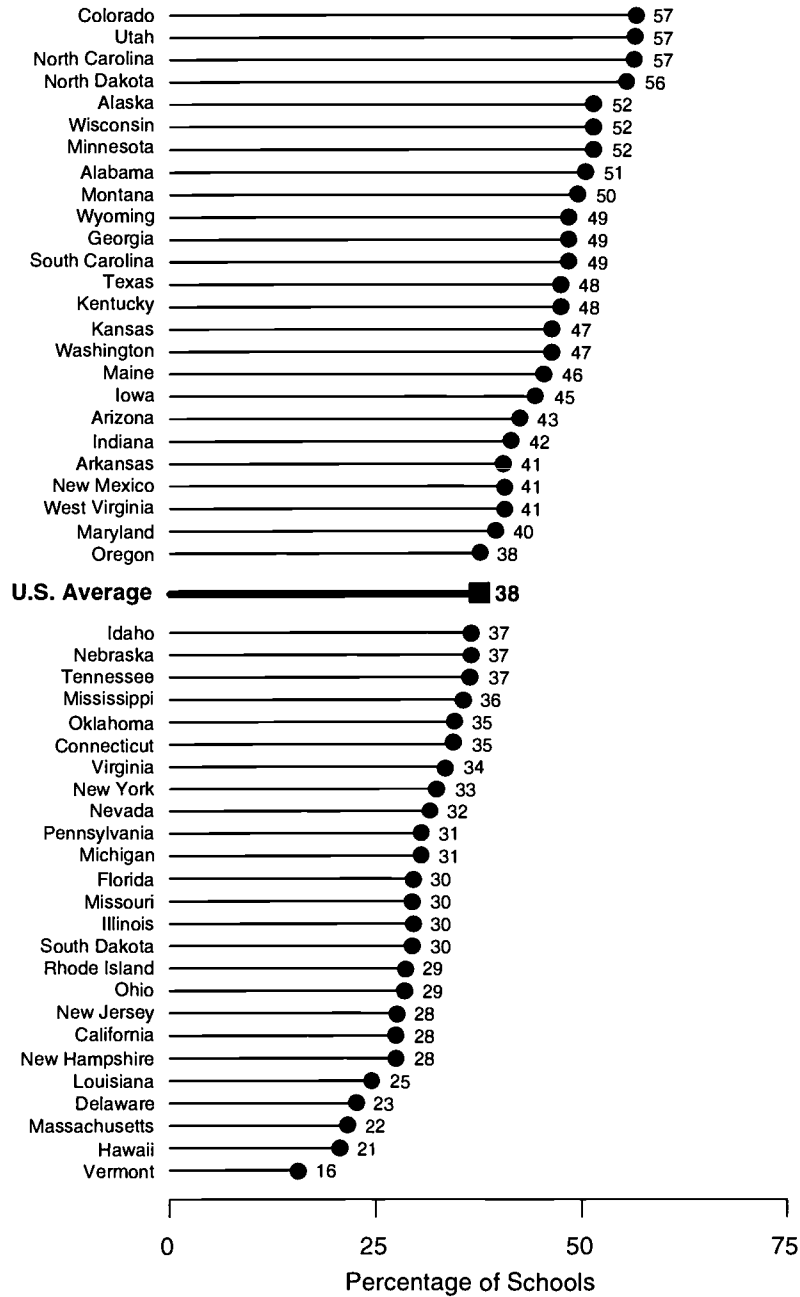

Source: QED, 1997.

VIDEODISC

Videodisc technology has been available for nearly two decades and has changed little compared to other technologies. What has changed is how this technology is used in schools. Once used in conjunction with a computer, videodiscs are now often used as a presentation tool. Just 35 percent of U.S. schools own videodisc players.

As with many of the other educational technologies discussed here, ownership increases with district and school size. Ownership also increases with grade level.

As shown in Figure 21, there is little difference in videodisc ownership among poor and rich schools. Figure 22 shows that schools with medium and high percentages of minority students are more likely to own videodisc players than schools with low percentages of minority students.

Figure 23 shows school videodisc ownership by state. Ninety-five percent of Florida's schools own videodisc players, compared to less than one-quarter of the schools in the bottom-ranking 15 states.

Figure 21: Relationship between the Percentage of Schools Owning Videodiscs and the Percentage of Title 1 Students

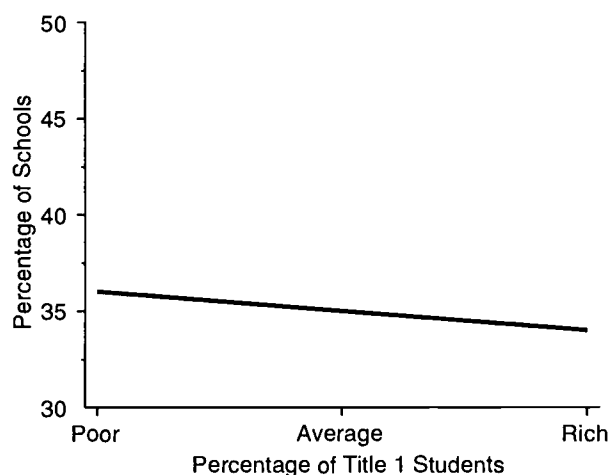

Source: QED, 1997.

Figure 22: Relationship between the Percentage of Schools Owning Videodiscs and the Percentage of Minority Students

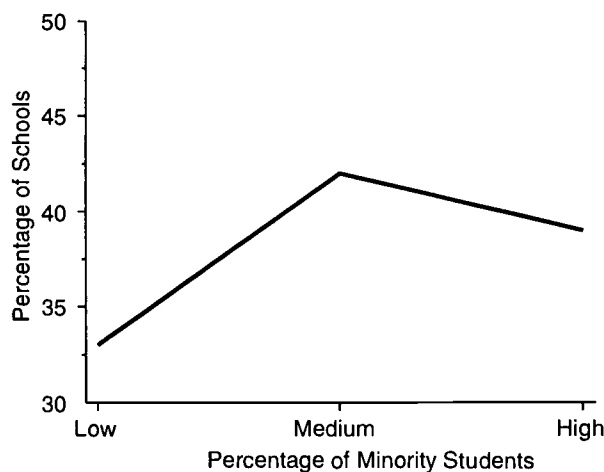

Source: QED, 1997.

Figure 23: Percentage of Schools with Videodisc Players, by State

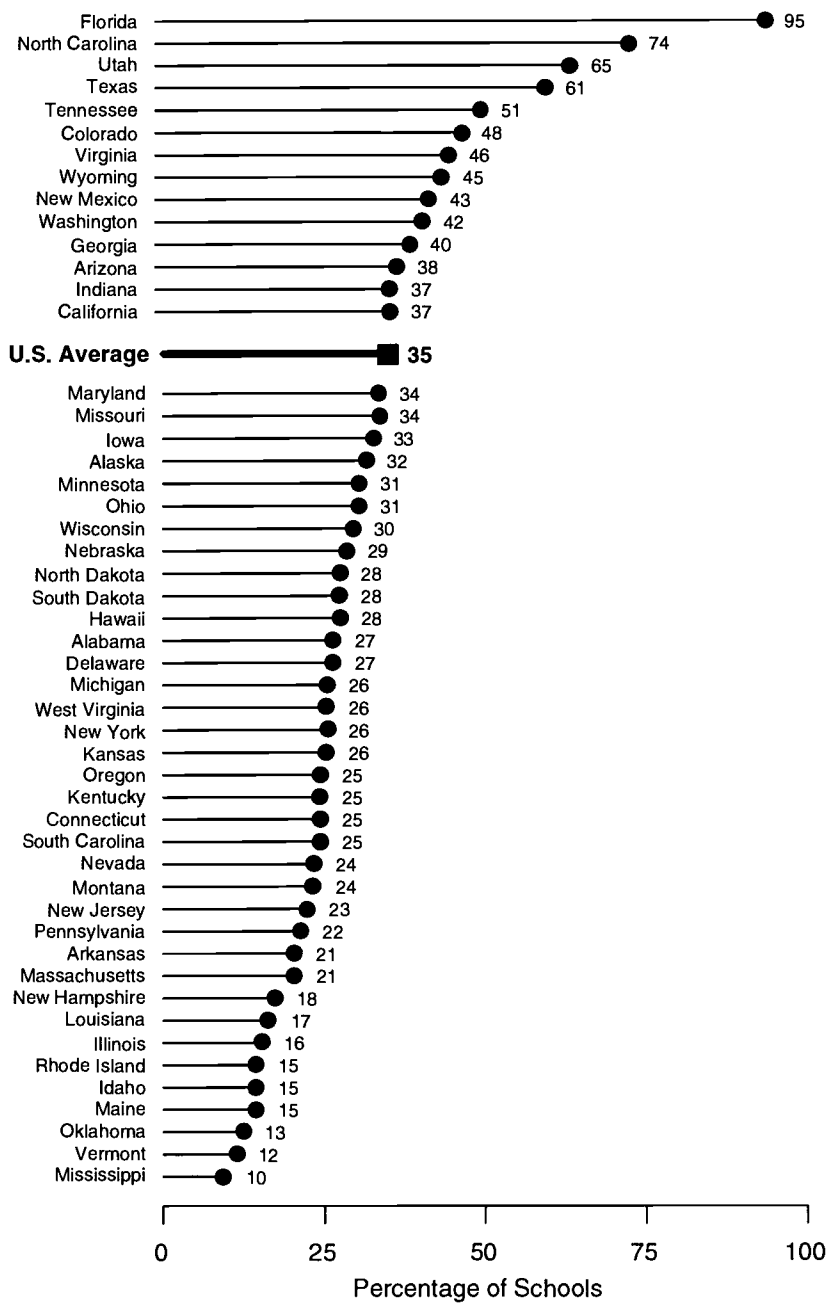

Source: QED, 1997.

SATELLITE TECHNOLOGY

Satellite use in elementary and secondary education grew as a result of increased interest in distance learning and the increased availability and variety of courses and staff development programs. Nineteen percent of U.S. schools had satellite systems in 1995-96.

Unlike most other technologies, satellite use for student instruction is comparatively high in small school districts. And while larger schools are more likely to take advantage of learning opportunities via satellite, this method is also used frequently in small and medium-sized schools. Like most other educational technologies, usage increases with grade level.

As shown in Figure 24, schools that are average in terms of the percentage of their students who qualify for Title 1 services are more likely to have satellite dishes than either poor schools or rich schools. Figure 25 shows that schools with low proportions of minority students are more likely to own this technology than schools with average or high minority concentra-

tions. While 21 percent of schools with low minority percentages own satellite dishes, only 15 percent of schools with high minority concentrations own this technology.

Figure 26 shows the variation among the states. About half of the schools in Missouri, Kentucky, and Montana own satellite dishes, compared to 5 percent or less of the schools in Rhode Island, New York, Maryland, Vermont, and Hawaii.

Figure 24: Relationship between the Percentage of Schools with Satellite Technology and the Percentage of Title 1 Students

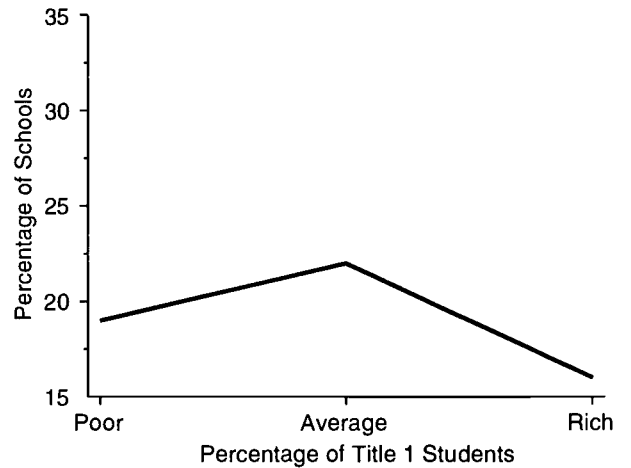

Source: QED, 1997.

Figure 25: Relationship between the Percentage of Schools with Satellite Technology and the Percentage of Minority Students

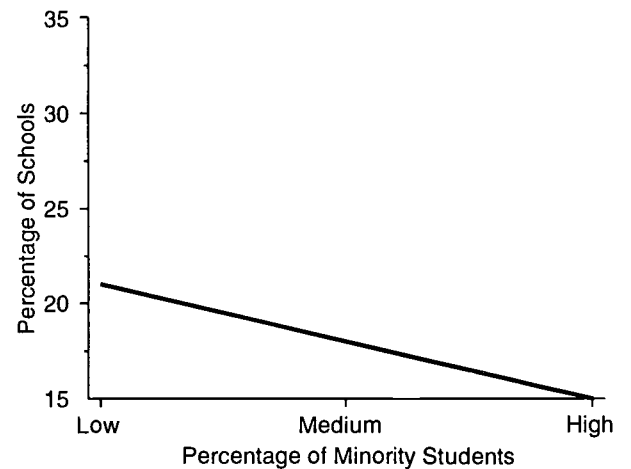

Source: QED, 1997.

Figure 26: Percentage of Schools with Satellite Technology, by State

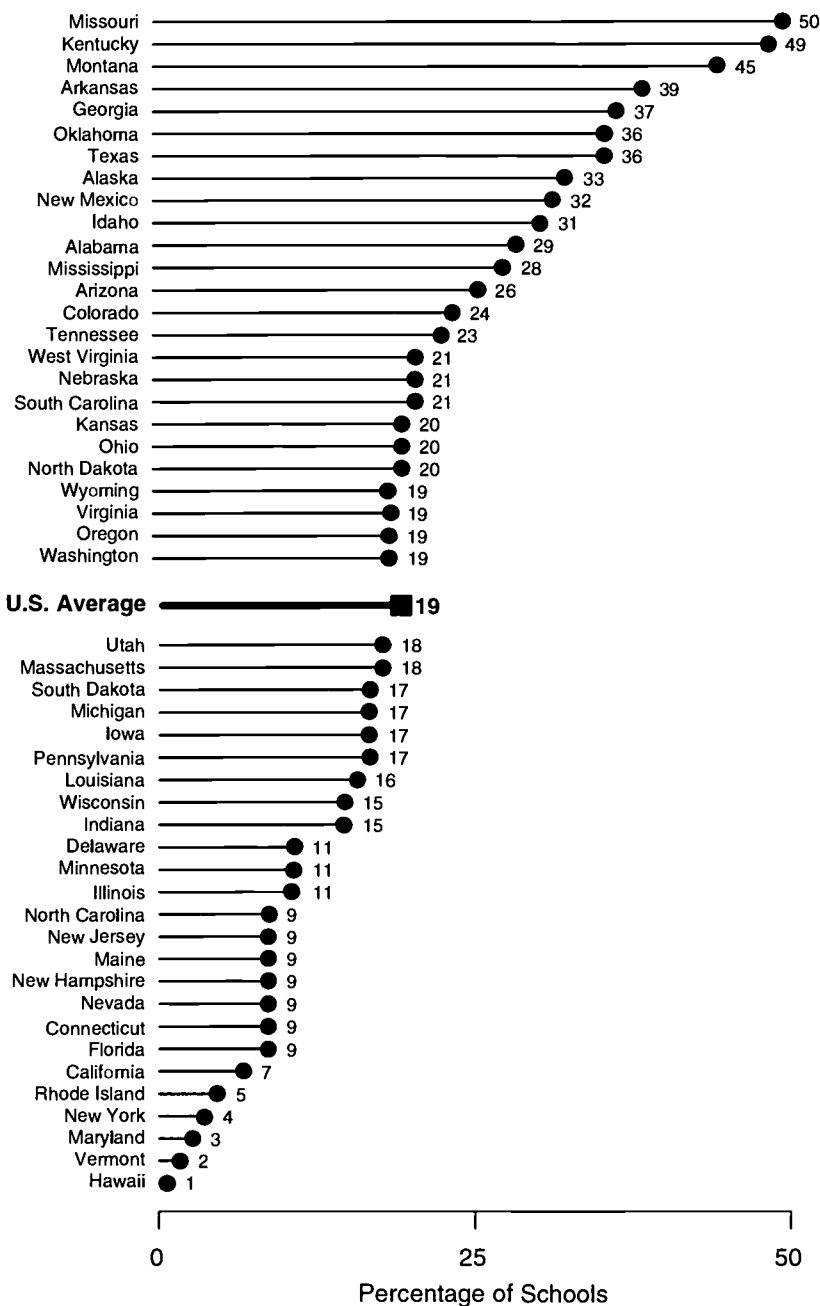

Source: QED, 1997.

- 1 Most of the data in this section of the report is drawn from *Technology in Public Schools, 15th Edition. Installed Base Technology in U.S. Public Schools, Covering 1981-1996*. Denver, CO: Quality Education Data. This annual publication is a census study of public school ownership of educational technologies for student instruction. To order copies of the report, call QED at 1-800-525-5811, email qedinfo@qeddata.com, or visit <http://www.qeddata.com>.
- 2 There are some differences in the poverty and minority measures from one type of technology to another. For computers and multimedia computers, QED provides actual percentage groupings. For the other technologies, with the exception noted below, QED provides broader groupings of schools — poor, average, rich; and low, medium, and high minority. The data on Internet access are from two sources. The state data are from QED and the poverty and minority data are from the National Center for Education Statistics. For this measure, NCES defines poor students as those who are eligible for free or reduced-price lunch.
- 3 Thomas K. Glennan and Arthur Melmed, *Fostering the Use of Educational Technology: Elements of a National Strategy*. Santa Monica, CA: RAND, 1996.
- 4 U.S. Department of Education, *Getting America's Students Ready for the 21st Century. Meeting the Technology Literacy Challenge*. June 1996.
- 5 The state data on Internet access are from QED, 1997. The data for poor and minority students are from *Advanced Telecommunications in U.S. Public Elementary and Secondary Schools, Fall 1996*. U. S. Department of Education, National Center for Education Statistics, February 1997.

BEST COPY AVAILABLE

Student Use of Computers

This section of the report examines data that allow us to see whether and how computers are being used in America's classrooms. Some of the data in this section is drawn from the most recent assessments that are available from the National Assessment of Educational Progress (NAEP). These NAEP data provide nationally representative information and allow us to examine differences among groups of students at different grade and age levels.¹

This section provides another perspective on student computer use by presenting data for the more than one million college-bound seniors who took the SAT in 1996. In addition to highlighting their high school experiences and courses related to computers, we can examine differences between boys and girls and among racial/ethnic groups. Changes over the decade are also described.

SCHOOL COMPUTER USE INFORMATION FROM NAEP

NAEP is the only nationally representative and continuing assessment of what America's students know and can do in various subject areas. In 1994, NAEP

Figure 1: Students' Use of Computers at Home and School, 1994

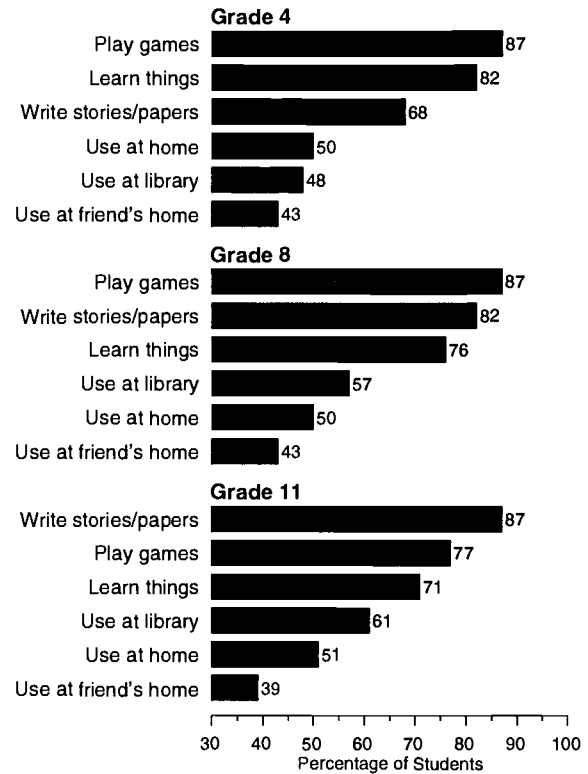

Source: Jay R. Campbell and others, *NAEP Trends in Academic Progress*, prepared by Educational Testing Service under contract with the National Center for Education Statistics, U.S. Department of Education, November 1996.

examined the ability of students in U.S. history, geography, reading, and mathematics. A key component of the assessment was the contextual information collected from students, teachers, and administrators. Topics included the frequency with which students are instructed using technology, and particularly, whether technology is used in the teaching of various subjects. This informa-

tion is reported for different groups of students so that comparisons can be made.

STUDENT USE OF COMPUTERS AT HOME AND SCHOOL

Students were asked about the contexts in which they used computers at home and in school. Their answers are shown in Figure 1 for each of three grade levels. Among fourth and eighth graders, playing

games at home and school was a prevalent computer use, followed by using the computer for learning things, and for writing stories or papers. The most frequent use among eleventh graders was writing. About half of the students said that they used a computer at home. A sizable proportion of the students indicated that they used a computer in a library. Fourth graders were more likely than the older students to use the computer to learn things. On the other hand, eighth and eleventh graders were more likely to use the computer for writing.

STUDENT USE OF COMPUTERS FOR SCHOOL WORK

In the 1994 NAEP reading assessment, students were asked how often they used a computer for school work. Figure 2 shows the breakdowns for each response category, for each grade level.

Computer use for school work increases at each grade level. At the fourth grade, 9 percent of students reported using a computer in school almost every day, compared to 10 percent of eighth graders, and 19 percent of twelfth graders. Twelfth graders were significantly more likely

than the other students to report almost daily use of the computer for school work.

There are some statistically significant differences among different groups of students.

- Black and Hispanic fourth graders were more likely than their White and Asian classmates to report almost daily use of computers in their school work.
- Fourth graders receiving Title I services were more likely to report daily computer use than were students not participating in this program.
- Fourth graders attending schools that ranked in the bottom third on NAEP reported more frequent use of computers than students in higher-scoring schools.
- White, Black, and Hispanic twelfth graders were more likely than their Asian classmates to report almost daily computer use.
- Twelfth graders receiving Title I services were more likely to report frequent use than students not receiving these services.

Figure 2: Students' Reports on the Frequency of Computer Use for School Work, 1994

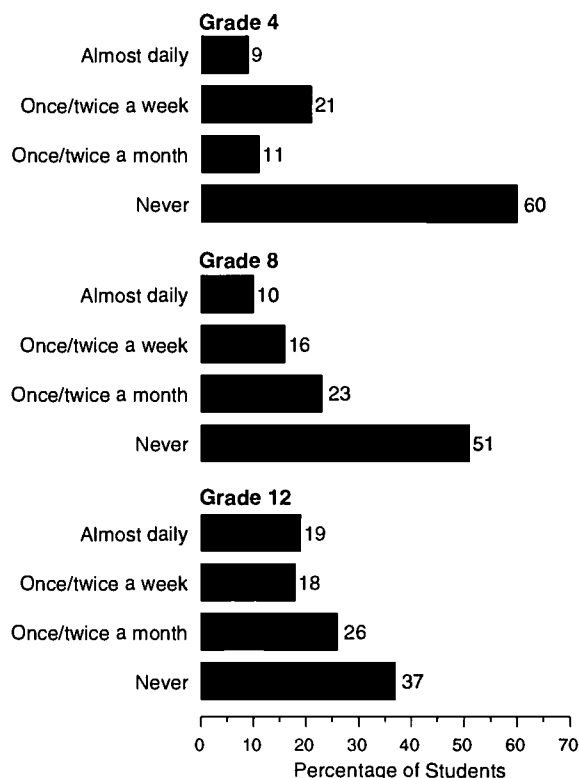

Source: 1994 NAEP Reading Assessment Electronic Data Almanac, Student Questionnaire.

- Twelfth graders attending rural/small town schools were more likely to report almost daily computer use than other students.

THE USE OF COMPUTERS IN TEACHING READING, U.S. HISTORY/SOCIAL STUDIES, AND GEOGRAPHY

Teachers of fourth and eighth graders were asked whether they used computer software for instruction in reading,

U.S. history/social studies, and geography. Figure 3 shows the percentage of students whose teachers said that they use computer software for instruction in these subjects. About 40 percent of the students in fourth grade had teachers who reported using the computer for instruction across the three subjects. In eighth grade, about a third reported computer use in teach-

Figure 3: Percentage of Students with Teachers Reporting the Use of Computers in Teaching Reading, U.S. History/Social Studies, and Geography, 1994

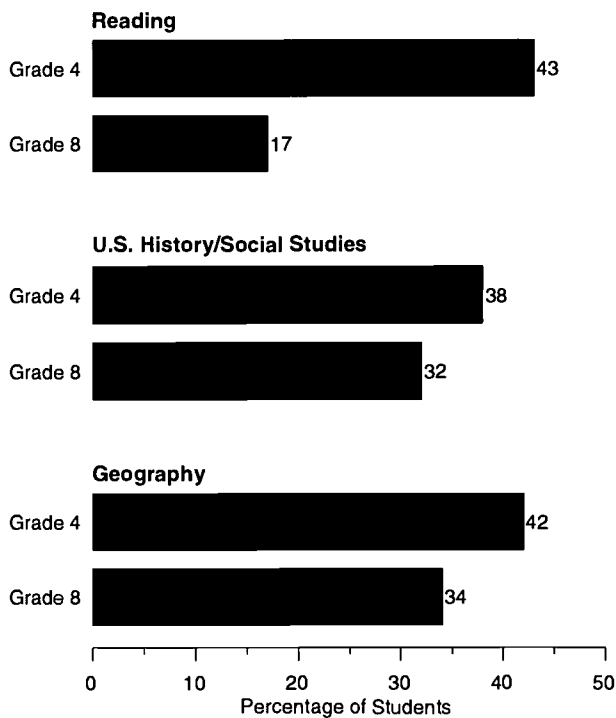

Source: 1994 NAEP Reading, History, Geography Assessment Electronic Data Almanacs, Teacher Questionnaire.

Figure 4: Students' Reports on the Availability and Use of Computers in Mathematics, 1994

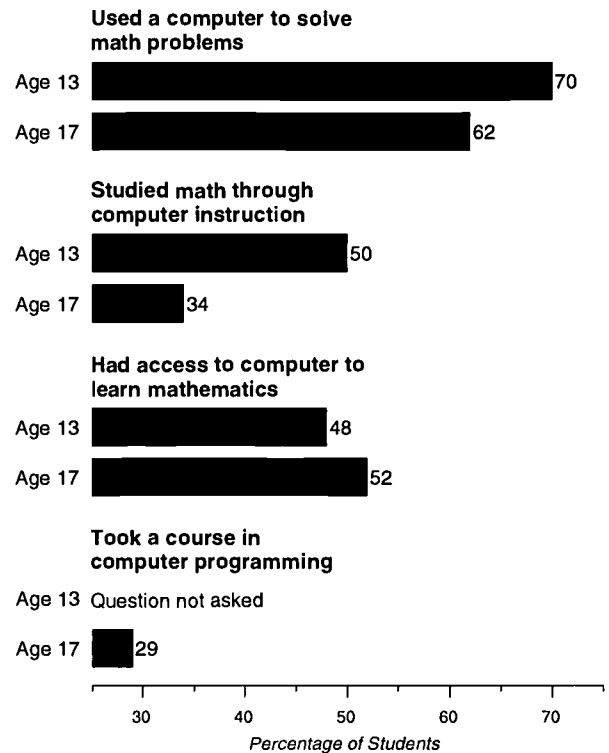

Source: Jay R. Campbell and others, NAEP 1994 Trends in Academic Progress, Prepared by Educational Testing Service under contract with the National Center for Education Statistics, November 1996.

ing U.S. history/social studies and geography, and 17 percent reported using the computer to teach reading.

There are some statistically significant differences among these groups of students:

- Computers were used to teach reading more in fourth grade than in eighth grade.
- White fourth graders were more likely than Black fourth graders to have teachers who used computers to teach geography.
- Fourth graders whose teachers indicated that their class was in the lowest ability group were the least likely to have teachers who used computers to teach geography.
- White eighth graders were more likely than their Black and Hispanic

classmates to have teachers who used computers to teach U.S. history/social studies.

STUDENT USE OF COMPUTERS IN MATHEMATICS

Thirteen and 17-year-olds were asked a number of questions about the availability and use of computers in mathematics instruction. These data are shown in Figure 4. About half of the nation's students, at

both age groups, had access to a computer to learn mathematics in 1994. Thirteen-year-olds were more likely than 17-year-olds to study mathematics through computer instruction and to use a computer to solve mathematics problems. Nearly a third of the nation's 17-year-olds had taken a computer programming course.

COMPUTER COURSEWORK AND EXPERIENCE OF COLLEGE-BOUND SENIORS

The College Board annually publishes data on the coursetaking patterns of college-bound seniors.² A look at these data over the last 10 years can give us some information on the level of coursetaking related to computers, and some information on trends. Students were asked whether they had any coursework or experience in certain areas. The response options (verbatim) were as follows:

- *I have had no course work or experience in this area*
- *Computer literacy, awareness, or appreciation*
- *Data processing*
- *Computer programming (BASIC, COBOL, FORTRAN, PASCAL, etc.)*
- *Use of the computer to solve math problems*
- *Use of the computer to solve problems in the social sciences*
- *Use of the computer to solve problems in the natural sciences*
- *Use of the computer in English courses*
- *Word processing (use of the computer in writing letters or preparing papers)*

A PROFILE OF THE CLASS OF 1996

Figure 5 shows the overall frequencies for each type of computer-related course or experience. For the Class of 1996, there were differences for types of computer coursetaking and experience. Figure 6 shows computer coursetaking in 1996 broken out by gender and race/ethnicity.

Word processing exposure was the most frequent — nearly three-quarters of the students had experience. There was little difference between boys and girls, but members of certain minority groups were less likely to have word processing experience. There was little difference between boys and girls, but members of certain minority groups were less likely to have word processing experience than were White and Asian students.

About half of the Class of 1996 had coursework or experience in computer literacy. Females and minority group students were less likely than males and White students to have such experience. While 54 percent of White students had computer literacy experience, only 41 percent of Black and Puerto Rican students did.

Forty-four percent of the Class of 1996 had used a computer in their English course, with females (45 percent) slightly ahead of males

Figure 5: Percentage of College-Bound Seniors* Reporting Computer Use or Experience, 1996

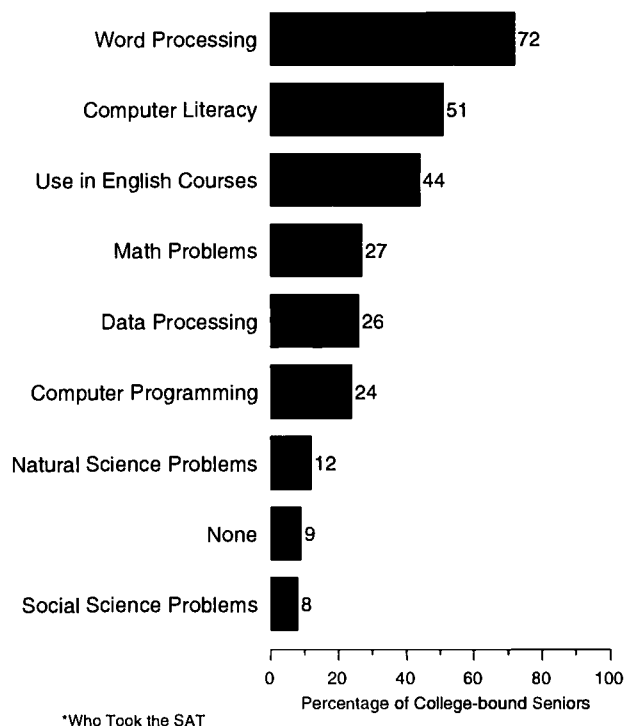

Source: 1996 College-Bound Seniors: A Profile of SAT Program Test Takers. The College Board, 1996

(42 percent). The biggest difference was that Mexican/American, Hispanic/Latino, Black, and Puerto Rican students were less likely than students from other racial/ethnic groups to use a computer in English class.

Computers were used in school to solve math problems by 27 percent of the seniors. Males (30 percent) were ahead of females (25 percent). And again, Black, Mexican American, Puerto Rican, and

Hispanic/Latino seniors were the least likely to use a computer in class to solve math problems, although this difference was small.

Data processing was taken in high school by about one-quarter of the Class of 1996. While the differences between the racial/ethnic groups were small, this was an area where students from minority groups were more likely than White students to take this particular coursework.

Figure 6: Computer-Related Coursework or Experience of College-Bound Seniors* by Gender and Race/Ethnicity

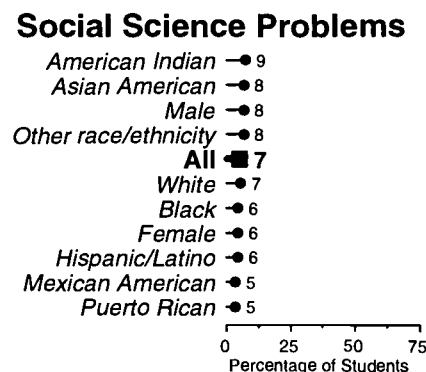
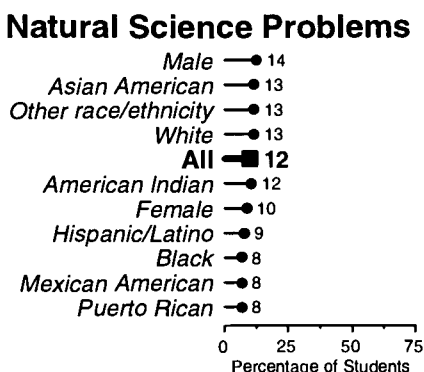
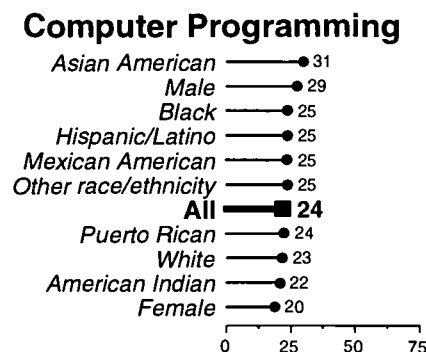
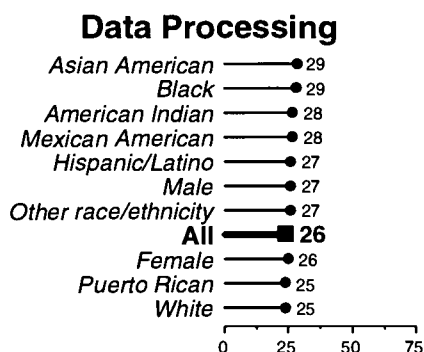
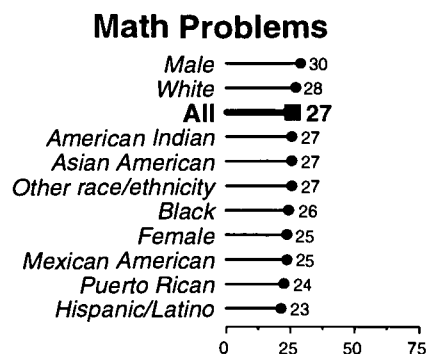
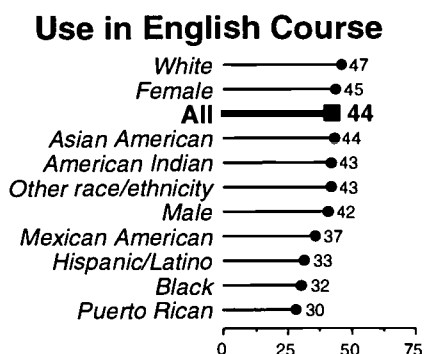
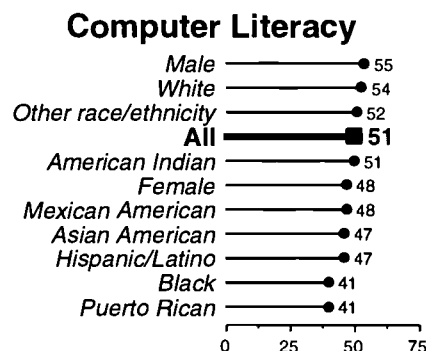
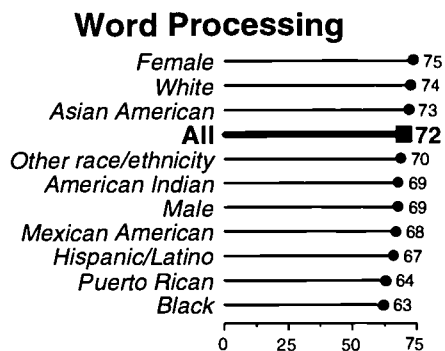

*Who took the SAT

Source: College-Bound Seniors unpublished data. The College Board.

Along with data processing, computer programming was a subject more likely to be taken by minority group students, although the differences are not large. There is quite a difference between boys and girls in taking computer programming, however — this coursework was taken by 29 percent of the boys and only 20 percent of the girls.

Fewer students used computers to solve natural science and/or social science problems. Only 12 percent of college-bound seniors used computers in natural science — 14 percent of the males and 10 percent of the females. Asian and White students were more likely than other students to use computers this way. Only 7 percent used computers to solve social science problems. Again, minority group students were less likely than other students to have this experience.

While not shown in the figure, only 9 percent of the Class of 1996 reported no computer experience in high school. Puerto Rican students (13 percent) were more likely to report no experience than other students.

CHANGE OVER THE DECADE

Figure 7 shows a line graph for each area of computer coursework or experience from 1987 until 1996. In general, students used technology more as the decade wore on. The percentage of college-bound seniors reporting no computer experience dropped from a high of 26 percent in 1987 to only 9 percent in 1996. The percentage of students reporting coursework or experience in computer programming dropped 20 percentage points — from 44 to 24 percent. There was a small drop in the percentage of students using technology to solve math problems — from 30 to 27 percent.

Increases were registered during the decade in all other areas. The largest increases were in word processing (up 36 percentage points, from 36 percent in 1987 to 72 percent in 1996) and in using computers in English courses (up 32 percentage points, from 12 percent in 1987 to 44 percent in 1996). Smaller increases are seen in computer literacy (up 10 percentage points), data processing (up 7 points),

natural science problems (up 6 points), and social science problems (up 3 points).

1 Because NAEP data provided in this section of the report are both cross-sectional and trend, students are assessed at different ages and grades. Thus, some data reported are for 17-year-olds, eleventh graders, and twelfth graders.

2 These data are for 1996 high school graduates who participated in the SAT program during their high school years. Composed of over one million students, this group represents about 93 percent of students entering four-year institutions and about 48 percent of all first-year students who enter college each year.

Figure 7: Percentage of College-Bound Seniors* Reporting Coursework in Various Subjects or Experience, 1996

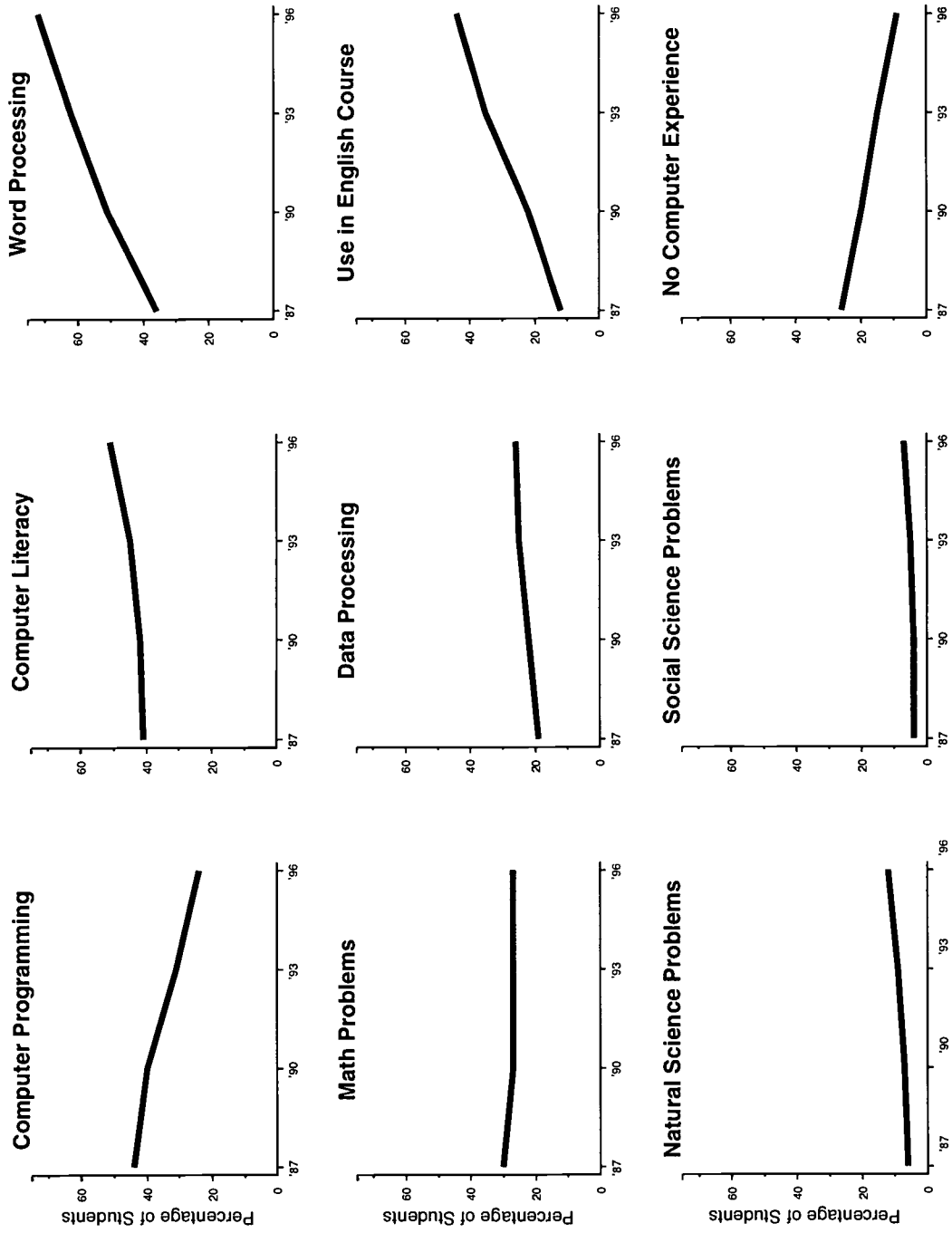

*Who took the SAT.

Source: 1996 College-Bound Seniors: A Profile of SAT Program Test Takers, The College Board, 1996.

Evaluating the Impact of Educational Technology

Will the use of computers in teaching fundamentally change the way we educate children, preparing them to live and work productively as the new millennium begins? What is the evidence that using educational technology can transform teaching and learning and improve student achievement? This section of the report provides a brief and select summary of the research on the effectiveness of educational technology in elementary and secondary education. Reviews of this research are available from other sources as well, and the findings are fairly consistent.¹

Rudimentary uses of computers in teaching, e.g., using drill-and-practice software to teach addition and subtraction, appear to be effective and efficient. More pedagogically complex uses of the computer, e.g., using the Internet in small groups to conduct collaborative research, often show inconclusive results, while sometimes offering promising and inviting educational vignettes.

To further complicate matters, it appears that the more complex and sophisticated the instructional design, the more

difficult the evaluation. This section also describes some of the methodological problems that arise in attempting to evaluate the impact of technology on teaching and learning.

WHAT THE RESEARCH SHOWS

The first part of this section describes the evidence on the effectiveness of technology used for computer-assisted instruction, basic skills instruction, and drill-and-practice types of software. The next section considers evidence available on the impact of more educationally complex types of technology applications. Until new and ongoing evaluations of cutting edge technology applications are available, the projects described here represent some of the best available evidence.

Rudimentary Technology Applications. Computer-based instruction can individualize instruction and give instant feedback to students, even explaining the correct answer. The computer is infinitely patient and non-judgmental. This motivates students to continue.

In trying to determine what is known about the effectiveness of educational technology, the RAND Corporation held a workshop for both researchers who had studied the effectiveness literature and practitioners who were involved in schools that made extensive use of technology. On this basis, RAND drew the following broad conclusion:²

Numerous studies of a wide variety of specific applications of technology show improvements in student performance, student motivation, teacher satisfaction, and other important educational outcomes.

James Kulik, a conference participant who has spent more than a decade analyzing studies of the use of computers for instruction, summarized his findings. A research approach called meta-analysis allowed him to aggregate research findings of many studies of computer-based instruction. Kulik summarized these findings as follows:

At least a dozen meta-analyses involving over 500 individual studies have been carried out to

answer questions about the effectiveness of computer-based instruction. The analyses were conducted independently by research teams at eight different research centers. The research teams focused on different uses of the computer with different populations, and they also differed in the methods they used to find studies and analyze study results. Nonetheless, each of the analyses yielded the conclusion that programs of computer-based instruction have a positive record in the evaluation literature.³

Kulik drew the following conclusions from this work:

- Students usually learn more in classes in which they receive computer-based instruction.
- Students learn their lessons in less time with computer-based instruction.
- Students also like their classes more when they receive computer help in them.
- Students develop more positive attitudes toward computers when they receive help from them in school.

- Computers do not, however, have positive effects in every area in which they were studied; the average effect of computer-based instruction in 34 studies of attitude toward subject matter was near zero.

It is important to note that, for the most part, the programs reviewed by Kulik were developed prior to 1990 and tended to emphasize drill and practice. Kulik's findings are similar to those of J.D. Fletcher, who studied the cost effectiveness of using technology in military training. In short, Fletcher's studies of computer-based instruction in military training repeatedly show gains of about one-third in training time.⁴

More recently, the Software Publishers Association commissioned an independent consulting firm to prepare a meta-analytic report on the effectiveness of technology in schools. Research from 1990 to 1995 was included, and 176 studies were analyzed. This report concludes "that the use of technology as a learning tool can make a measurable difference in student achievement, attitudes, and interactions with teachers and other

students." With respect to achievement, positive effects were found for all major subject areas, in preschool through higher education, and for both regular education and special needs education. Student attitudes toward learning and student self-concept were both found to be increased consistently in a technology-rich environment across the studies included. In general, (although not necessarily for low-achieving students who tended to require more structure) student control (self-pacing) was found to be one of the more positive factors relating to achievement when technology was used.⁵

Numerous studies have demonstrated that technology is particularly valuable in improving student writing.⁶ For example, the ease with which students can edit their written work using word processors makes them more willing to do so, which in turn improves the quality of their writing. Studies have shown that students are more comfortable with and adept at critiquing and editing written work if it is exchanged over a computer network with students they know. And student writing that is shared with other students over a network

tends to be of higher quality than writing produced for in-class use only.

Technology has also been shown to have other effects on students. The use of technology in the classroom improves students' motivation and attitudes about themselves and about learning. Technology-rich schools report higher attendance rates and lower dropout rates than in the past. Students are found to be challenged, engaged, and more independent when using technology. By encouraging experimentation and exploration of new frontiers of knowledge on their own through the use of technology, students gain a greater sense of responsibility for their work — producing higher-quality assignments that reflect the increased depth and breadth of their knowledge and talent. And technology energizes students, because they often know more about its operation than do their teachers.⁷

More Cognitive Applications of Technology. The RAND report goes on to say that the "more cognitive" applications of technology are more difficult to evaluate — the research data are less extensive,

the data that exist are harder to organize, and new evaluation designs are often needed. These more cognitive applications can engage students in authentic tasks, often with other students, using computer network software and databases that are intended not only to improve subject matter learning, but to develop skills in cooperation, communication, and problem solving. Evidence on the effectiveness of some of these technology applications is provided below.

A recent report by Beatrice Berman and her colleagues at the American Institutes for Research provides descriptions and findings of several recent studies and ongoing projects that investigate the implementation, effectiveness, and role of technology with large numbers of teachers and students in the context of educational reform efforts.⁸ Until new and ongoing evaluations of cutting-edge educational technology projects are available, the findings from the projects cited below represent the best of currently available research.

- *The Role of Online Communications in Schools: A National Study.* This project, conducted by CAST (Center for Applied Special Technologies), is based on the premise that online use is best introduced into schools within the context of what is already happening in the classroom. The study compared the work of 22 fourth- and sixth-grade classes in seven urban school districts — half with access to online communications and the Internet and half without. The student work was part of a semi-structured instructional unit completed over a two-month period. The goal was for all classes to study issues of civil rights by researching civil rights topics, sharing information, and completing a final project. CAST researchers found that:

- Fourth-grade students with online access scored significantly higher on two of nine learning measures
- Sixth-grade students with online access scored significantly higher on four of nine learning measures

The CAST researchers argue that the study provides additional

evidence that online access can help students become independent, critical thinkers, able to find information, organize and evaluate it, and then effectively express their new knowledge and ideas in compelling ways.⁹

- *Technology's Role in Education Reform.* This is a four-year national study conducted by Barbara Means and Kerry Olson and their colleagues, which seeks to understand how technology can support constructivist teaching at the classroom level, and to describe and analyze technology implementation factors. Schools or projects were selected for study which served substantial numbers of poor students. The most common effects on students were an increase in motivation and improvements in academic performance. Overall, the researchers reported that the use of technology in their case study schools had a positive effect. Of the eight single-school sites, seven reported lower than average rates of teacher turnover, six reported higher student attendance rates, and five had higher test scores than a comparison group. Fewer

disciplinary incidents were also reported.¹⁰

- *Union City Interactive Multimedia Education Trial.* The Union City, New Jersey, school district implemented a five-year plan that included a significant investment in technology to support its curriculum reform goals. Bell Atlantic worked with the city, the state board of education, and the Education Development Center's Center for Children and Technology to carry out a technology trial at two schools. While the district's comprehensive reform program has yielded substantial gains in student progress, results at Christopher Columbus Intermediate School are even more encouraging.
 - Columbus students had the highest overall pass-rates of any district school on practice administrations of New Jersey's Early Warning Test.
 - More Columbus students qualified for the ninth-grade honors program than did students from any other city school.
 - The Columbus School has held the district's best attendance record

for both students and faculty for the past two years.

- The school had the highest number of transfers in and the fewest numbers of transfers out between 1993 and 1995.¹¹
- *Higher Order Thinking Skills Program (HOTS)*. Begun in the early 1980s as an alternative approach to Title 1, HOTS has evolved into a widely used and effective intervention for disadvantaged fourth- through seventh-graders. HOTS is a pull-out program created to build the thinking skills of students through exposure to a combination of computers, drama, and Socratic dialogue, which are combined via a detailed and creative curriculum. Recent reports note the following results:
 - Increased thinking and social confidence of participating students
 - Doubled national average gains on reading and math test scores
 - Ten to 15 percent of the Title 1 and learning disabled students made the honor roll in 1994, suggesting a transfer of the students' cognitive development to learning specific content

- Increased performance on measures of reading comprehension, meta-cognition, writing, components of IQ, transfer to novel tasks, and GPA

- HOTS students also outperformed a control group of students in a traditional Title 1 program on all measures¹²

- *Assessing the Growth: The Buddy Project Evaluation, 1994-95*. The state of Indiana, along with the Lilly Endowment and Ameritech, sponsored this project that supplied students with home computers and modem access to the school. An assessment of the project indicated significant differences between seven Buddy Project classrooms compared to three non-Buddy Project classrooms in different schools. Positive effects included:

- An increase in all writing skills
- Better understanding and broader view of math
- More confidence with computer skills

- Ability to teach others

- Greater problem-solving and critical-thinking skills

- Greater self-confidence and self-esteem

- *Apple Classrooms of Tomorrow (ACOT)*. ACOT focused on the changed instructional practices and student learning that occurred when extensive access to technology was provided at the classroom level. In its initial years (before laptops), each student and teacher was given two computers, one for home and one for school. Over 10 years of research, the ACOT project says that independent researchers found that ACOT students not only continued to perform well on standardized tests but were also developing a number of competencies not usually measured. According to this research, ACOT students:

- Explored and represented information dynamically and in many forms

- Became socially aware and more confident

- Communicated effectively about complex processes

- Used technology routinely and appropriately

- Became independent learners and self-starters

- Knew their areas of expertise and shared that expertise spontaneously

- Worked well collaboratively

- Developed a positive orientation to the future¹³

- *CHILD (Computers Helping Instruction and Learning Development)*.¹⁴ This project was a five-year investigation in nine Florida elementary schools that began in 1987. Over 1,400 students participated and their teachers received training which included not only the technological components of the program (three to six computers were placed in each classroom) but also emphasized establishing a team environment with other teachers in the project. Much of the students' daily routine involved self-paced interactions in a learn-

ing station environment. "Student empowerment" was a key concept of the project. Standardized test scores indicated a positive and significant result across all grades, schools, and subjects, with the largest effects appearing for students who had been in the program for more than one year. When surveyed, none of the nine schools expressed dissatisfaction with the project, five were planning to expand their level of participation, and nine new schools were about to become involved.

EVALUATION ISSUES

When we try to determine the effectiveness of educational technologies we are confronted by a number of methodological and practical issues. First, we need to remember that technology is only one component of an instructional activity. Assessments of the impact of technology are really assessments of instruction enabled by technology, and the outcomes are highly dependent on the quality of the implementation of the instructional design.

According to Roy Pea, the "social contexts" of technology uses are crucial to understanding

how technology may influence teaching and learning. Whatever else is "effective," it is *not* educational technologies per se. The social contexts are *all* important. They include not only the technology but its content, the teaching strategies used both "in" the software and "around it" in the classroom, and the classroom environment itself. It is a recurrent finding that the effects of the best software can be neutralized through improper use, and that even poorly designed software can be creatively extended to serve important learning goals.¹⁵

There are also a host of methodological issues to confront. First, standardized achievement tests may not measure the types of changes in students that educational technology reformers are looking for. New measures, some of which are currently under development, would assess areas that many believe can be particularly affected by using new technologies, such as higher order thinking.

There is also a need to include outcome measures that go beyond student achievement, because student

achievement may be affected by students' attitudes about themselves, school, and learning, and by the types of interactions that go on in schools.

In addition, technological changes are likely to be nonlinear, and may show effects not only on student learning, but also on the curricula, the nature of instruction, the school culture, and the fundamental ways that teachers do their jobs.¹⁶

Ellen Mandinach and Hugh Cline have explored many of the challenges to the scientific examination of technology's impact on education and suggest the need to focus on longitudinal design, multiple methods, multiple levels of analysis, and systems analysis in lieu of traditional methodologies. Traditional research designs are inadequate, inappropriate, and often ask the naive question, "Does it work?" The impact of technology is too multifaceted for such a simple question. There is impact on: students' learning and motivation; classroom dynamics, including interactions among students, teachers, and the technology; and schools as formal organizations. Perhaps

the most important evaluative lesson is the absolute necessity for researchers to remain flexible in applying their methodological knowledge in a field setting, i.e., to make continuous adjustments in all aspects of implementation and assessment efforts to gain a more thorough understanding of technology's impact on teaching and learning activities.¹⁷

A final issue is that evaluators are often chasing a moving target. While policymakers and the public may want to know whether investing in a particular type of statewide computer network is worthwhile, by the time evaluation data are collected and analyzed, the particular network may be obsolete and another investment opportunity presents itself that needs to be explored.

AN EXAMPLE FROM THE FIELD

Finally, this section describes the experiences of a team of researchers at Educational Testing Service (ETS) that is currently grappling with the issues involved in documenting and evaluating the New Jersey Networking Infrastructure in Educa-

tion Project, funded by the National Science Foundation, which is aimed at enhancing elementary and secondary science education through the use of the Internet.¹⁸

The project's goal is to connect 500 schools to the Internet, to train teachers to access and use the Internet and, ultimately, develop science curricula that draw from the Internet and its wealth of real-time data. Gita Wilder, who heads the evaluation effort, has identified four issues that have arisen from the New Jersey project and probably apply to any effort to evaluate technology-based innovation in schools and classrooms.

1. It is impossible to systematically assess cognitive and achievement outcomes for students without addressing variations in their starting points and differences in program implementation. Such issues include the variety of forms that project implementation takes, the rapid rates of change in hardware and software, and the inevitable need for additional information on the program, e.g., in changes in infrastructure, budget, school or district sup-

port, and teacher background.

2. It is simplistic to suggest that the introduction of technology, given variations in starting points and implementation, can produce comparable outcomes among classes and students.
3. While the motivational and attentional benefits of technology for students have been widely reported, the cognitive and achievement effects have not been as consistently cataloged. There is a need for scholars and teachers to:
 - work together to develop hypotheses about how students' cognitive processes and school achievement might be affected by the consistent and innovative application of technology
 - test these hypotheses in small and controlled studies
 - design larger-scale field studies that test the results under a range of classroom and school conditions
4. Finally, although it is common practice to act as though change in

teaching practice is relatively unimportant in the catalog of expected outcomes, it is important to realize that the teacher is the constant in the equations. Students move on and are affected by conditions that are both cumulative and changing; teachers remain to influence many generations of students. Teacher effects should be considered as important as student effects, and probably more influential in the long run.

1 See, e.g., <http://www.mcrel.org/> impact. Also see John Cradler, "Summary of Current Research and Evaluation Findings on Technology in Education," (<http://www.fwl.org/techpolicy/refind.html>).

2 Thomas K. Glennan and Arthur Melmed, *Fostering the Use of Educational Technology: Elements of a National Strategy*, Santa Monica, CA: RAND, 1996.

3 See James A. Kulik, Meta-Analytic Studies of Findings on Computer-based Instruction, "in E.L. Baker and H.F. O'Neil, Jr. (eds.), *Technology Assessment in Education and Training*, Hillsdale, NJ: Lawrence Erlbaum, 1994.

4 J.D. Fletcher, D.E. Hawley, and P.K. Piele, "Costs, Effects and Utility of Microcomputer Assisted Instruction in the Classroom," *American Educational Research Journal*, 27, 1990, pp. 783-806.

5 Jay Sivin-Kachala and Ellen R. Bialo, *Report on the Effectiveness of Technology in Schools 1990-1994*, Washington, DC: Software Publishers Association, 1994.

6 U.S. Department of Education, *Getting America's Students Ready for the 21st Century. Meeting the Technology Literacy Challenge*, June 1996.

7 U.S. Department of Education, 1996.

8 Beatrice F. Birman and others, *The Effectiveness of Using Technology in K-12 Education: A Preliminary Framework and Review*, Washington, DC: American Institutes for Research, January 1997.

9 For more information on this project, see Center for Applied Special Technology, *The Role of Online Communications in Schools: A National Study*, Peabody, MA: CAST, 1996. Also, see <http://www.cast.org/sststudy.html>.

10 For information on this project, see Barbara Means and Kerry Olson, *Technology's Role in Education Reform: Findings from a National Study of Innovating Schools*, Washington, DC: U.S. Department of Education, Office of Educational Research and Improvement, 1995.

11 For more information on this project, see M. Honey and A. Henriquez, *Union City Interactive Multimedia Education Trial: 1993-95 Summary Report*, Princeton, NJ: Educational Development Center, Inc., Center for Children and Technology, 1996.

12 For more information on HOTS, see S. Pogrow, "Using Computers and Other Visual Technology to Combine Process and Content," in A. Costa and R. Liebman (eds.), *When Process Is Content: Toward Renaissance Learning*, Corwin Press, 1996.

13 For more information, see Apple Computer, Inc., *Changing the Conversation about Teaching, Learning, and Technology: A Report on Ten Years of ACOT Research*, Cupertino, CA: 1995.

14 This description is drawn from Elizabeth Wellburn, *The Status of Technology in the Education System: A Literature Review* (http://www.etc.bc.ca/lists/nuggets/EdTech_report.html).

15 Roy Pea, "Learning and Teaching with Educational Technologies," in H.J. Walberg & G.D. Haertel (eds.), *Educational Psychology: Effective Practices and Policies*, Berkeley, CA: McCutchan Publishers, 1996.

16 U.S. Congress, Office of Technology Assessment, *Teachers and Technology: Making the Connection*, OTA-EHR-616, Washington, DC: U.S. Government Printing Office, April 1995.

- 17 E. B. Mandinach, and H. F. Cline, *Methodological Implications for Examining the Impact of Technology-based Innovations: The Corruption of a Research Design*. Paper presented at the annual meeting of the American Educational Research Association, Chicago, 1997.
- 18 This information was provided in a personal communication between Gita Wilder and Richard Coley of ETS, March 5, 1997.

Connecting Teachers and Technology

Goal 1 of President Clinton's National Technology Literacy Challenge states that:

- *All teachers in the nation will have the training and support they need to help students learn using computers and the information superhighway.*

This goal reflects the growing recognition that staff development and ongoing technical assistance are prerequisites for effective and sustained applications of technology in education. To achieve this goal, technology training will need to reach teachers and administrators as well as future educators in preservice programs. There is also an increasing awareness of the need for preservice and inservice training that is informed by research on effective instructional practices and emphasizes teaching strategies that draw on a variety of technologies across the curriculum.

The importance of teacher training in the use and integration of technology is documented by empirical research conducted in California schools that were recipients of technology grants. The study concluded that at least 30

percent of any educational technology budget should be earmarked for teacher staff development with follow-up support and assistance. Similar findings have been reported in other states.¹

This section of the report begins with a brief overview of teachers' preparation to use educational technology in the classroom. It discusses barriers to helping teachers use technology in their teaching, and describes some current thinking about and practices in staff development, including the use of telecommunications and the involvement of administrators. Finally, based on current research and experience, several suggested directions for staff development are offered.

CURRENT STATUS OF STAFF DEVELOPMENT FOR TECHNOLOGY USE

If our ambition is to provide technology training and support for all teachers, a fair question seems to be, how far are we from reaching that goal? Results from a recent survey shown in Figure 1 delineate the percentage of teachers, by state, who had received at least nine

hours of educational technology training in 1994. The percentages, by individual states, range from a low of 8 percent to a high of 28 percent with most states ranging between 10 and 20 percent. The nationwide average is 15 percent. And as shown in Figure 2, 32 states require teacher candidates to take courses in educational technology in order to obtain a license.²

A recent survey from the National Center for Education Statistics provides additional information about current levels of teacher access to technology training. Thirteen percent of all public schools have mandated telecommunications training for teachers either by local regulations or state statute. The survey indicates that a third (31 percent) of the states provides incentives for telecommunications training, and only about 16 percent of teachers currently use telecommunications for professional development across the country. However, the rapid increase in school level access to the Internet — from 35 percent in 1994 to 65 percent in 1996 to 87 percent projected for 2000 — may signal new

Figure 1: Percentage of Teachers Who Had at Least Nine Hours of Training in Education Technology in 1994

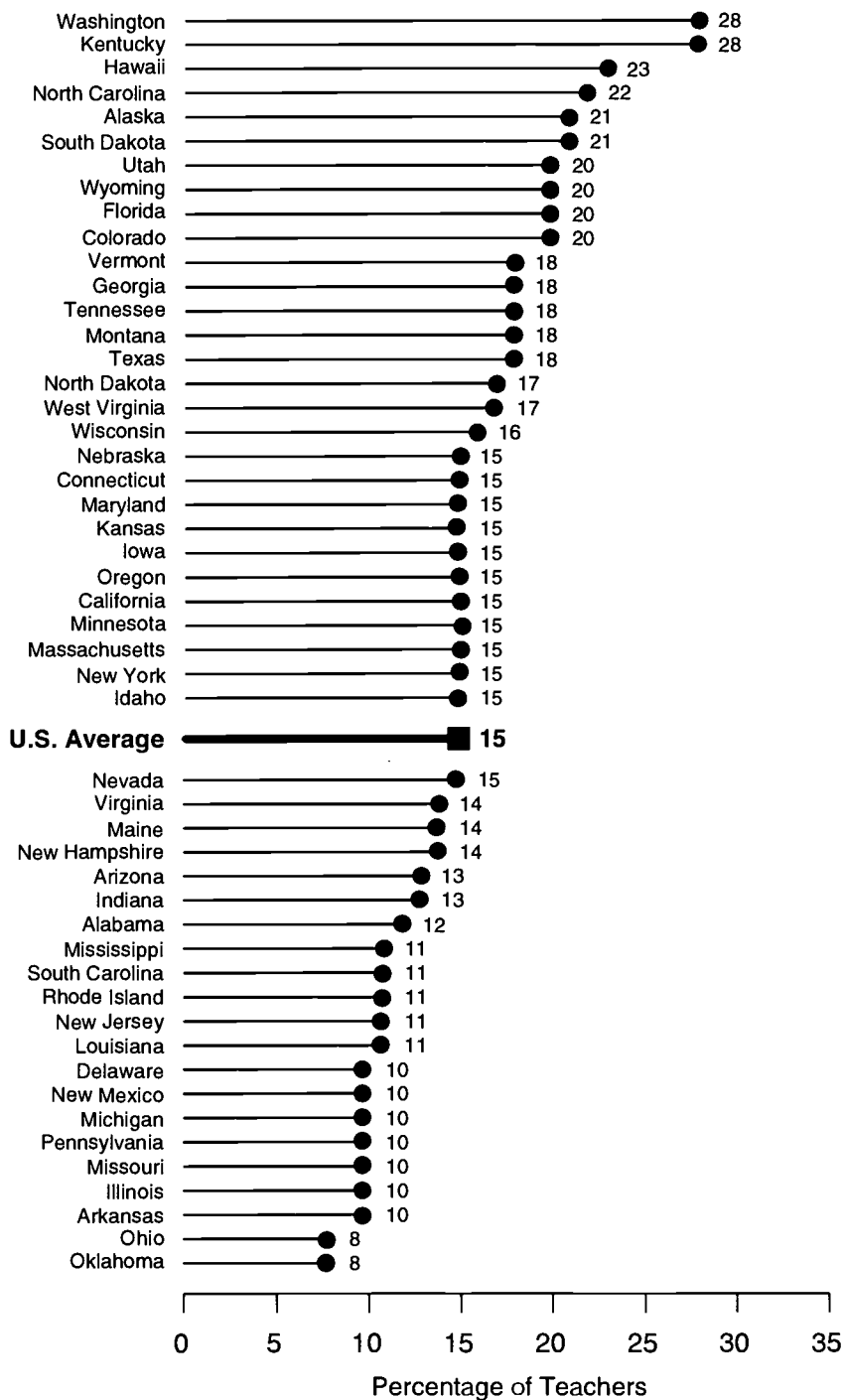

Source: Education Week. *Quality Counts: A Report Card on the Condition of Public Education in the 50 States*. January 22, 1997

opportunities for teacher access to professional development through telecommunications.³

In 1995, the Office of Technology Assessment (OTA) conducted a comprehensive study of teachers and the effective use of technology in schools. The key findings of this study include:

- Most teachers have not had suitable training to prepare them to use technology in their teaching.
- In a majority of schools, there is no onsite support person officially assigned to coordinate or facilitate the use of technologies.
- To use technology effectively, teachers need more than just training about how to work the machines and technical support.
- Schools and school districts are using a number of different approaches for training teachers and implementing technology.
- Lessons from experienced implementation sites suggest that those who wish to invest in technology should plan to invest substantially in human resources.

Figure 2: States Requiring Courses in Educational Technology for a Teaching License, 1996



Source: Education Week. *Quality Counts: A Report Card on the Condition of Public Education in the 50 States*. January 22, 1997.

the training and/or support needed to resolve the problems.

- Many feel the need for more technical and pedagogical knowledge — not just about how to run the machines, but also about what software to use, how to integrate it into the curriculum, and how to organize classroom activities using technology.
- Many school, district, and/or state assessment systems rely heavily on standardized achievement tests, which can be a barrier to experimentation with new technologies because teachers are not sure whether the results they are seeking will be reflected in improved student test scores.

- Support for technology use from the principal and other administrators, from parents and the community, and from colleagues can create a climate that encourages innovation and sustained use.

- Although sites have made significant progress in helping teachers learn to use generic technology, tools such as word processors, databases, and desktop publishing programs, many still struggle with how to integrate technology into the curriculum.

- Schools should avoid acquiring technology for technology's sake. Developing a technology plan at the local site in support of school improvement goals and involving teachers in the planning process are important steps in ensuring that the technology will be used by those it is intended to support.⁴

Given the speed with which technology is changing and changing our lives, the research and survey data make it clear that the task of training the current and future teaching force is formidable.

BARRIERS TO EFFECTIVE TECHNOLOGY USE

The OTA study found that helping teachers learn how to integrate technology into the curriculum may be one of the most critical factors for successful implementation of technology applications in schools. The study also identified some major challenges facing teachers as they try to come up to speed with technology applications:

- Many teachers encounter technical and logistical problems and often lack

- Issues created by technology itself are also factors to be dealt with, including those related to copyright and intellectual property rights, privacy of student records, and control of student access to objectionable materials.

Inevitable technical and logistical problems that are part and parcel of using technology are why teachers consistently emphasize the need for onsite assistance. Common problems include machines that won't work as promised, restricted

access to locked closets filled with equipment, media carts that must be scheduled and shared among many classrooms, equipment that remains broken for weeks or even months because no one knows how to fix it, and the long time taken to process repair requests. When teachers were asked to cite the one factor that would most likely determine whether or not they would use a computer in teaching, one teacher summed it up:

If I could have a few hours one-to-one with a really competent teacher that has used it—just let me ask questions [about] what I'm afraid of about a computer, what I don't understand.⁵

MODELS FOR CONNECTING TEACHERS AND TECHNOLOGY

The challenge of integrating technology into schools and classrooms is much more human than it is technological. It is not fundamentally about helping people to operate machines. Rather, it is about helping teachers integrate these technologies into their teaching as tools of a profession that is being redefined through the process.⁶

The National Staff Development Council (NSDC) recently com-

pleted a comprehensive study of the lessons learned about staff development in the past 20 years. From this study, NSDC developed a set of staff development guidelines that can be applied to the development of teacher capacity to implement any educational innovation or initiative, including the educational application and integration of technology.⁷

These guidelines reflect a constructivist perspective. Rather than receiving knowledge from experts in training sessions, teachers and administrators should collaborate with peers, researchers, and students to make sense of the teaching and learning process in their own contexts. Staff development would include activities such as action research; conversations with peers about the beliefs and assumptions that guide individual instruction; reflective practices such as journal keeping; projects involving families and community members in student learning; and actively contributing to the growing body of knowledge about the

nature of teaching and learning in the technological age. While these are activities that many educators may not even view as staff development, new paradigms of professional development that reflect new understandings about teaching and learning are gradually becoming a reality.⁸

Using Telecommunications. These new staff development paradigms are supported by the resources and tools made available through telecommunications and other new technologies. In the past, educators were limited to opportunities they could access in person. Now, with a computer, telecommunications access, and videoconferencing, educators from all over the country can interact with each other, take online courses, and readily access the latest research in their discipline.

In fact, educators are increasingly using telecommunications for professional development activities. A study by the Center for Technology in Education found that collegial exchanges, including communicating via e-mail to colleagues and posting questions or exchanging ideas on

forms and bulletin boards, are the services most frequently used for professional purposes.

Working as the only computer specialist in the school and district, it is invaluable to me to have contact with other professionals using computers in new and innovative ways. Informal questions can be asked. Help can be received in an inexpensive way. Discussions on software, equipment, and programs can be generated.

District Computer Specialist⁹

Educators report a range of incentives for using telecommunications as a professional resource. Networking activities play a critical role in increasing professionalism and relieving the isolation typically experienced by teachers. Teachers view the opportunity to communicate with other teachers and share ideas as one of the major benefits of this technology. Obtaining rapid feedback on curricular issues and other topics of professional interest, and keeping current on subject matter, pedagogy, and technology trends are also important incentives.

I have been able to meet and work and learn with such a variety of educational professionals that it is rather like being in continuous attendance at a large international conference.

High School
Science Teacher¹⁰

A Variety of Approaches. Education institutions across the country are developing approaches to helping teachers use technology from which others can benefit. The approaches differ, depending upon the existing resources (human and technological) at a site, the visions the sites have developed for how technologies are to be used and what problems they can address, and the leadership and support that are available to meet those goals. These approaches include the following:

- Developing technology-rich classrooms, schools, or districts, in which local expertise in various applications of technology can be developed and shared
- Training master teachers, who then serve as resources or mentors for their colleagues
- Providing expert resource people from other dis-

ciplines, such as librarians, computer coordinators, or volunteers from business, parent, and student groups

- Giving every teacher a computer, Internet access, and the training and time to develop personal confidence and expertise
- Training administrators so they can serve as technology supporters and guide efforts within their schools or jurisdiction
- Establishing teacher or technology resource centers, ideally with ease of teacher access through online services
- Establishing telementoring programs
- Incorporating technology into existing staff development programs
- Promoting individualized planning for staff development
- Delivering interactive staff development via satellite and Internet

Many schools combine several of these approaches, and there is no clear evidence that any one model is more successful than

others. There are numerous additional examples of effective strategies for supporting teachers' needs for professional development in this age of technology and telecommunications. The following projects have been or are currently being studied to inform the educational community of effective practices.

- *Challenge Grants for Technology in Education.* Forty-four Challenge Grants have been funded in the first two years of this program. These federally funded research projects are testing innovative ways of using technology and telecommunications to involve teachers and communities in the development of new curricular resources, use of telecommunications to deliver courses to students throughout the United States, train teachers in new technological skills, and create online learning communities for teachers across the projects. In the first year, over one million students were served and thousands of teachers were trained to make effective use of computers in their classrooms.

- *Vanguard for Learning.* The National Science Foundation (NSF) and the Department of Defense Dependent Schools (DoDDS) are studying strategies for creating learning communities of students, educators, families, and military base personnel related to the unique needs and resources of the particular community, and for integrating these strategies into the school system. The professional development model is one of action research in which collaborative teams of teachers are designing classroom-based projects which integrate new technologies with research-based instructional practices. Support is provided in-person and online and includes an online university course.¹¹
- *The Well Connected Educator.* The goals of this NSF-funded project include creating an arena for educators to publish; disseminating lessons learned; providing a forum for the discussion of educational technology issues; encouraging reflective practice and collaboration; and promoting thinking among teachers, administrators, and others in the education

community about the impact of technology on learning and education reform. All elements of *The Well Connected Educator* are peer-reviewed. The articles are read by an editorial board supervised by the editorial director of the International Society of Technology in Education (ISTE). Forums are carefully moderated and monitored by a team of expert moderators.

- *The Cupertino (CA) Model Technology Schools Project*. This project developed and studied the Personalized Learning Plan (PLP) — a strategy for professional development. The PLP was developed by individual teachers to identify the specific staff development and technology-based training they needed to more effectively integrate technology into their teaching. The evaluation of the PLP process showed that when teachers identified their staff development needs and when these needs were met through customized training, there was a positive impact on classroom instruction and there was a significant increase in the use of technologies in the model schools. Further, teachers became more innovative in developing

curriculum and applications of technology.

- *The Apple Classroom of Tomorrow (ACOT)*. This project lasted nearly a decade and has provided information on the support teachers need to integrate technology in order to foster new ways of student learning. Strategies for supporting the professional needs of teachers included team teaching and planning, modified school schedules for planning and instruction, technology skills development related to specific teaching needs, use of source materials to support curriculum planning, and reflection on student progress to modify teaching practice. This project and its outcomes are described in another section of this report.
- *Telementoring Programs*. These programs are numerous and are supported by states as well as research grants. The state of Hawaii has used telementoring for the past several years to foster collegial training across islands; California's Telemation Project uses telecommunications to bring teachers together from all regions of the state;

NSF's National School Networking Project uses telecommunications to support hundreds of telementors around the country. The Milken Family Foundation is supporting statewide telementoring projects established as part of state Technology Literacy Challenge Fund plans.

INVOLVING ADMINISTRATORS

Research on the adoption of innovations in schools consistently points to the key role of administrative leaders in successful implementation. Involved and supportive superintendents are essential to district-wide reform efforts, and principals are key to implementation within the school building.¹² Research has consistently found that when administrators are informed about and comfortable with technology, they become key players in leading and supporting technology integration activities in their schools.¹³

Some technology implementation efforts are building on these lessons by including principals or other key administrative staff in training opportunities offered to teachers. One such approach is to

include principals in school-based teams chosen to receive intensive training in technology use. For example, the Apple Classroom of Tomorrow Teacher Development Center Project looks at the commitment of the principal when selecting teacher teams for training. Not only are principals encouraged to attend portions of the training program with the teacher team, but they also must commit to the following conditions: release time for teachers to attend project training sessions; time for teachers to meet and plan each day; time for teachers to reflect on practice; and acknowledgment of the importance of their teachers' efforts to the rest of the staff.

Since 1990, Indiana has sponsored a state-wide training program specifically for principals. In its first two years, the Principals' Technology Leadership Training Program served almost 400 Indiana principals. Over the course of a year, each principal takes four days of professional training with other principals at a central site. By scheduling sessions at different points in the year, the program built in

time for principals to go back to their schools, practice what they learned, and talk to staff and better define what they needed and wanted. In the workshops, principals learned about a broad range of technology and software available for classroom and office use and had a chance for hands-on exploration of a large collection of equipment.

Participating principals have been very enthusiastic about the Technology Leadership Program. In addition to reporting increased knowledge and confidence with respect to technology use, participating principals said they were more capable of creatively using capital project funds, writing grants, or justifying expenditures to school boards. After the training, many principals conducted training for their teachers; others reported that they were better equipped to think comprehensively about the technology in their schools and how best to use it. Principals rated an update session, held the following year, as very valuable, and most principals endorsed the need for some kind of ongoing "refresher programs."

In summary, the overriding theme of this section of the report has been the importance of staff development for effective use of technology in schools. From interviews with teachers and educational technology leaders and a review of the literature, we begin to see that effective technology training for teachers reaches beyond proficiency in using computers and draws on lessons learned about implementing effective staff development and instructional reform in schools. To tap into the power of technology as an educational tool, research and experience indicate that staff development should:

- Be driven by a clear understanding of the local needs of teachers
- Emphasize hands-on experience, especially for technology use training
- Use peer coaching rather than lecture format
- Integrate technology training into other staff development programs in the school and district

- Involve administrators as participants with teachers in staff development programs on technology use and integration in the curriculum
- Provide the release time needed for teachers to apply what they learned in training
- Provide follow-up support for implementation of technology skills learned in training
- Give teachers access to resources needed to implement what was learned in training
- Facilitate communications among teachers — use telecommunications technologies to help teachers communicate and share their professional experiences

- 5 Janet Schofield, *Computers and Classroom Culture*. New York: Cambridge University Press, in press.
- 6 Barbara Means, et al., *Using Technology to Support Education Reform*, Washington, DC: U.S. Department of Education, 1993.
- 7 Dennis Sparks, "A Paradigm Shift in Staff Development," *Education Week*, March 1994.
- 8 John Cradler and Elizabeth Parish, *Telecommunications and Technology in Education: What Have We Learned by Research and Experience?*, WestEd Regional Laboratory, October 1995.
- 9 Margaret Honey and Andres Henriquez, *Telecommunication and K-12 Educators: Findings from a National Survey*, New York, NY: Center for Technology in Education, Bank Street College of Education, 1993.
- 10 OTA, 1995.
- 11 John Cradler, Ruthmary Cradler and Peggy Kelly, *Vanguard Professional Development Quarterly Report*, October 15, 1996. (Report is available via email from cradler@cerfnet.com).
- 12 OTA, 1995.
- 13 U.S. Congress, Office of Technology Assessment, *Power On! New Tools for Teaching and Learning*, Washington, DC: U.S. Government Printing Office, 1988.

- 1 John Cradler, et al., *The Analysis of the Impact of California Educational Technology Regional and Local Assistance Programs*, conducted for the California State Department of Education, WestEd Regional Laboratory, 1992.
- 2 *Education Week*, "Quality Counts: A Report Card on the Condition of Public Education in the 50 States," January 22, 1997.
- 3 National Center for Education Statistics, *Advanced Telecommunications in U.S. Public Elementary and Secondary Schools*, Fall 1996, U.S. Department of Education, Office of Educational Research and Improvement, February 1997.
- 4 U.S. Congress, Office of Technology Assessment, *Teachers and Technology: Making the Connection*, OTA-HER-616, Washington, DC: U.S. Government Printing Office, April 1995.

Assessing the Content and Quality of Courseware

Goal 4 of President Clinton's National Technology Literacy Challenge is that:

- *Effective software and on-line learning resources will be an integral part of every school's curriculum.*

Computer software, video, distance learning courses, and online resources are expanding rapidly. The U.S. Department of Education estimates that over 20,000 educational software titles have been developed (including CD-ROM and multimedia packages), more than a million students take courses through distance learning via networks every year, and every day hundreds of new home pages are added to the Internet's World Wide Web.¹ These instructional resources (hereafter referred to as "courseware") have the potential to improve learning by engaging students in experiences not previously accessible on a large scale.

The rapidly increasing access to and use of technology in education, as shown in previous sections of this report, are creating a corresponding need for the development of courseware that exploits the

potential of technology as a tool for teaching and learning. The challenge is two-fold: To develop products that extend learning opportunities beyond what can already be offered with traditional instructional media, and to provide resources and processes to enable educators to select and use courseware in ways that help students meet high standards.

Research consistently shows that curriculum content, instructional strategies adjusted to learner needs, along with sufficient incentives and opportunities to learn are the major "keys" to effective teaching and learning. Consequently, when technology is brought into the instructional equation, it is effective to the extent that it supports and enhances these "keys." In other words, if technology is applied to inadequate content and instructional strategies, the desired educational outcomes will be elusive.

Any examination of the impact of courseware on learning must start with an assessment of the extent to which such resources are designed to target specific learning objectives and curriculum standards. Products that are carefully

designed to support specific learning objectives with consideration for the research on how students learn have the highest probability of producing desired learning outcomes.² Next, courseware needs to be matched to national, state, district, or local standards. Finally, the courseware must be integrated into the teaching and learning activities of the classroom.

This section provides an overview of a process for the effective design, selection, and integrated utilization of technology in order to maximize its impact on learning. Figure 1 describes this process visually. The "road map" illustrates the process suggested for, first, evaluating courseware based on defined standards and priorities, and second, selecting and integrating courseware into instructional practice.

The following sections of this report address several issues regarding the current status of courseware and describe current efforts to evaluate courseware. A recent assessment of the "quality" and content emphasis of courseware in several subjects is also provided. The section concludes by suggesting several actions shown by research and experience

Figure 1: Courseware Evaluation and Application "Road Map"

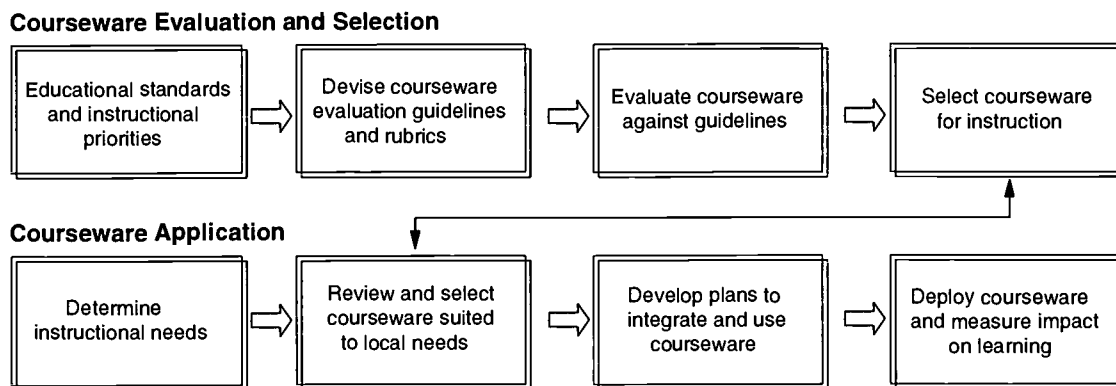

to be effective in courseware development.

THE INSTRUCTIONAL DESIGN OF COURSEWARE

In 1988, Policy Analysis for California Education (PACE) commissioned an analysis of technology in education and the conclusions of that report remain valid today.³ For the past 15 years, research has shown that all types of instructional materials are generally more effective when their development has been informed by learning research. For example, a study of teaching and learning found that careful instructional planning, clearly defined objectives, clear presentation, student interaction, opportunities for feed-

back, and time engaged in on-task behavior together have the greatest probability of increasing learning.⁴

Further studies by Robert Slavin found that instructional programs were effective when they adopted models or validated practices that presented consistent and convincing evidence of instructional effectiveness.⁵

Research-based criteria for the development of effective curriculum and instructional strategies should also be applied to the development and selection of educational courseware. Research has found that, "too often software designers focus on the technical qualities of their programs rather than attending to the

kind of learning experience that should be created."⁶

Other research has concluded that materials are often selected for their broad content or topic with little consideration for their fit with learners' needs, or for the delivery system most appropriate for the learning objectives. Without serious integration into the curriculum, technology may bring change without improvement.⁷

The criteria for courseware development should reflect the components for effective curriculum and instructional strategies and the software should be field tested for effectiveness in producing desired effects before being widely

distributed. It is the content and instructional design rather than the courseware per se that will influence learning. The following sections discuss a tested process for applying content and instructional design to both the selection and development of courseware.

THE CALIFORNIA INSTRUCTIONAL TECHNOLOGY CLEARINGHOUSE

In 1985, the California State Department of Education determined that technology could serve as a catalyst for implementing the state curriculum frameworks and student performance standards. In order to utilize technology for this purpose it

was necessary to establish and determine the extent to which existing courseware had the potential to support the frameworks and standards. What emerged from this process was a statewide courseware “consumer’s guide” for educators. The concept evolved into the establishment of the state-funded California Instructional Technology Clearinghouse (CITC) in 1987.

Today, the CITC is a major and unique resource for courseware evaluations and was the only source found by this report’s authors that conducts and disseminates analyses and evaluations of courseware based on educational standards.⁸ Most commercially developed courseware is submitted to the CITC. The U.S. Department of Education’s Office of Educational Technology recommends the CITC as a national resource for courseware reviews and evaluations.

Over the past 12 years, the CITC has involved curriculum specialists and teachers in the development and application of guidelines for analyzing courseware with respect to content, quality, and technical features. These guide-

lines are used to both inform the selection of existing courseware and influence the development of new courseware.

The California Curriculum Frameworks and national education standards are the basis for the content guidelines.⁹ And because most textbook publishers heed California’s curriculum standards, due in part to the size of the California market, the CITC is as close to a national clearinghouse as exists today. This section describes the CITC and its evaluation process.

THE CITC EVALUATION STRATEGY

The CITC uses a five-step strategy that begins with the development of guidelines and continues on to include training, courseware reviews, identifying courseware needs, and dissemination. This strategy includes the following steps:

1. **Develop Courseware Evaluation Criteria and Guidelines.**

These guidelines were informed by state and national curriculum standards and instructional requirements as well as student, staff,

community, and system-wide needs. The guidelines also include standards for technical features, user features, training and support needs of teachers, as well as legal compliance. These guidelines are listed in the box on the next page.

2. **Establish Courseware Assessment Training.**

A training program based on the *Courseware Evaluation Criteria and Guidelines* was developed. The training is designed to provide educators with the capacity to conduct in-depth courseware evaluations and to test the courseware with students in classrooms to determine student reaction.

3. **Conduct Courseware Reviews.**

Evaluators next assess the commercial courseware made available by most publishers. The major steps in the review process are outlined below:

a. All courseware are pre-screened to determine if they meet the basic essential criteria. These include:

- appears to cover California curriculum and performance standards

- program objectives are clear
- technology used is an effective medium for the content
- content is current and accurate
- presentation design is technically accurate and can maintain student interest
- support materials provided are helpful
- audio and visual features are clear and appropriate for classroom viewing
- technical quality and publisher support are adequate

b. Products are then each reviewed by two “experienced” reviewers to determine the extent to which the products meet the CITC guidelines or rubrics.

c. Products that pass steps a) and b) are then tried out with students.

d. Curriculum specialists review the products to determine appropriate match to the content recommended in the California instructional resources evaluation instruments (which are applied to all state-

adopted materials, including textbooks), the state curriculum frameworks, and the state content and performance standards.

e. Products are given a final rating.

f. Descriptive annotations for programs rated as *exemplary* or *desirable* are prepared and entered in the CITC database for access on the Web, CD-ROM, or in printed form.

4. **Identify Courseware Needs.** After the reviewers determine the specific courseware that meet the CITC Guidelines, this information may be used to determine needs and priorities for the development of new courseware to fill the “gaps” where there are not existing products.

5. **Clearinghouse Information Dissemination.** The CITC provides electronic access to information about courseware that meets the CITC Guidelines. The exemplary products are displayed at selected county offices of education and regional service agencies.

THE CITC EVALUATION GUIDELINES

Recently, the CITC revised and expanded the guidelines for the evaluation of courseware. The guidelines are designed to provide a single set of rubrics that can be applicable to the evaluation of all types of courseware used in schools today, including rubrics for evaluating educational resources on the Internet. The guidelines are intended to define criteria of excellence that can provide suggested directions for those publishers and producers who strive to improve their products.¹⁰

The new guidelines are organized into five sections, each with several subsections:

1) Content

curriculum content, including match with standards and curriculum frameworks
legal compliance (not racially or gender biased, etc.)

2) Instructional Design

creative teaching and learning approaches are embedded
critical thinking and decision making activities are embedded
information literacy such as online searches is emphasized
stereotypes are avoided, variety of cultures and career roles are included
English learners (ESL) are supported
challenged learners' needs are addressed in specific ways

3) Program Design

objectives and pedagogy are clear and relevant
effective use of technology for the content
interactive strategies allow focus on instruction, not program mechanics
motivating for all students
customizing features for teachers and/or students
online access, as appropriate
skills-building programs involve learners beyond drill-and-practice

4) Assessment

classroom management methods to chart student progress
assessment strategies are well-designed for a wide range of needs

5) Instructional Support Materials

presentation and organization of materials is clearly written
support materials are provided in print or printable form

Each of the guidelines is evaluated by three categories of evaluation rubrics or ratings:¹¹

- *Exemplary* — makes an excellent case for recommendation
- *Desirable* — makes a good case for recommendation
- *Minimal* — makes a minimal case for recommendation

Only courseware judged to be “exemplary” or “desirable” are recommended for use in the schools. Excellence in technical and instructional quality is expected, but that alone is not enough to recommend any program for schools.

The CITC rubrics provide educators with a description of what to look for when applying each of the rating criteria to each of the rubric categories. For example, to have an excellent rating for curriculum content the evaluator must observe that . . .

“ . . . the program covers the content recommended in California’s instructional resources evaluation instruments, curriculum frameworks, and content and performance standards.”

GUIDANCE FOR COURSEWARE DEVELOPERS

Like textbook publishers, software publishers consult existing curriculum frameworks and standards to inform the design of courseware. Several states have translated their curriculum frameworks and standards into software development guidelines. Such guidelines were used to help guide the development of several *exemplary* multimedia programs. These include *Vital Links*, *Science 2000*, and others developed as part of the Software Development Partnership Program jointly funded by Florida, Texas, and California. Earlier partnerships included products such as *Voyage of the Mimi*, which combined the use of video and computer programs, and the Star Schools distance learning programs.

Because these programs were developed in close partnership with state and local curriculum designers, researchers, and teachers, they emerged as some of the most comprehensive and sustainable programs to be developed to date. These findings are supported

by a statement from a software publisher:

*We definitely need teachers to help identify good software—to put some models out there that producers can emulate. Teachers need to be involved in separating the wheat from the chaff.*¹²

The recent U.S. Department of Education report, *Getting America's Students Ready for the 21st Century*, says that "states and districts have an important role to play in ensuring that effective educational software is available for students and their teachers. To ensure that suitable software is

available, states and districts can work closely with software producers to develop software that meets the needs and goals of their students."

THE QUALITY OF CURRENT COURSEWARE

CITC data are consistently showing that effective courseware varies greatly in availability. The most recent findings about the quantity of courseware recommended by the CITC for each subject area, for multidisciplinary use, and for cross-grade applications are provided below.¹³ The implications of these findings for the future planning and

development of software and online resources are discussed.

As Table 1 shows, only between 6 and 8 percent of the courseware across all subject areas were rated as *exemplary* by the CITC and from 33 to 47 percent as *desirable* from 1991 to 1995. The programs evaluated were only those that passed the initial screening process which rejects programs that are clearly out of alignment with the curriculum frameworks, do not meet legal compliance criteria, or clearly lack the technical quality for consideration by the reviewers. About 42 percent of all course-

Table 1. Number and Percentage of Courseware Rated as Exemplary, Desirable, and Not Recommended by the CITC from 1991 to 1995

	1991-92		1992-93		1993-94		1994-95		91-95 Average	
	#	%	#	%	#	%	#	%	#	%
"Exemplary"	20	8	12	8	10	6	21	9	16	8
"Desirable"	78	33	74	47	70	39	89	40	78	39
Not Recommended	138	58	71	45	101	56	113	51	106	53
Programs Evaluated	236		157		181		223		200	

Source: CITC Software/CD-ROM Data Base. <http://tfc.stan-co.k12.ca.us>.

were submitted to the CITC passed the initial screening. Changes in curriculum priorities along with advances in technology necessitate an annual re-evaluation of programs. However, many 1991 programs are still in the database since they were advanced enough to remain as *desirable* or *exemplary*. These data suggest an overall need for additional courseware that meets content-based criteria as defined by the CITC, as well as further study on this issue.

Table 2 provides data on the numbers and percentages of courseware accepted for review and then rated as *exemplary* and *desirable* for mathematics, science, English/language arts, and history/social studies.

As the data indicate, the highest percentage of courseware accepted for CITC review was classified as emphasizing science, with English/language arts second, followed by history/social studies and mathematics. It should be noted that some programs are cross-curricular and are rated as more than one subject. This accounts for the fact that the total programs across subjects is greater than the total

Table 2. The Number and Percentage of Programs Rated as *Exemplary* and *Desirable* for Science, Mathematics, History/Social Science, and English/Language Arts, 1995

Curriculum Topic	Total Accepted		<i>Desirable</i>		<i>Exemplary</i>	
	Number	Percent	Number	Percent	Number	Percent
Mathematics	135	21	107	82	28	21
Science	295	47	235	80	60	20
English/Language Arts	242	38	191	79	51	21
History/Social Studies	208	33	153	74	55	26
Total Accepted	637		516	81	121	20
Source: CITC Software/CD-ROM Data Base, http://ftc.stan-co.k12.ca.us .						

programs reviewed. The differences between subjects in terms of ratings are probably not significant as the range is from 74 to 82 percent for *desirable* and 21 to 26 percent for programs rated *exemplary*.

Data are not yet available to examine the ratings by grade level groupings. However, such an analysis is being conducted as part of an effort to determine specific subject areas for specific grade levels where there are "holes" in terms of available products.

In general, it appears that there is a need, as reported by the CITC reviewers, for more *exemplary* or *desirable*

programs at all grade levels in all subject areas. Reviewers often comment that more courseware is needed that provide more in-depth treatment of subjects, and that utilize multiple technologies — especially the Internet.

Future research should identify the specific reasons that programs were not accepted for in-depth review and analysis and what needs to be done to correct the weaknesses in such products. Also, data should be collected on the areas in the curriculum where there is a lack of *exemplary* and *desirable* programs, along with recommendations

about the types of products needed to fill these "holes."

Once acceptable products are identified, research needs to be conducted on the comparative impact of *exemplary* and *desirable* programs vs. other programs in terms of impact on teaching and learning. The CITC assumes that *exemplary* programs will produce a greater impact on learning than *desirable* or non-acceptable programs. However, research does not exist to either support or refute this assumption. Presently, a study being conducted for the Department of Defense Schools (DoDDS) will

be testing the hypothesis that greater student benefits will result with courseware that meets CITC and DoDDS standards.¹⁴

INTEGRATING EFFECTIVE COURSEWARE

The most highly rated courseware is only effective to the extent that it is effectively integrated into instruction. A lesson learned from numerous model technology school projects, including the California Model Technology Schools and the Apple Classroom of Tomorrow (ACOT), is that the successful integration of technology in classrooms implies a change in the underlying strategies of classroom teaching. These innovations require a clear vision and an implementation plan based on available resources, student needs, and school goals. Educators need to develop a "road map" or plan to achieve the desired goals.¹⁵

A systematic process for integrating technology into the curriculum was developed and validated within several projects over the past 10 years. The process involves the development of a classroom level *Technology Integra-*

tion Plan (TIP) whereby the teacher individually or as part of a team develops a detailed plan for the integration and use of technology within the context of classroom curriculum and instruction. In applying this process, educators select courseware that has already been recommended by the CITC and then incorporated into school and classroom-level TIPs (see Figure 2). In general, the TIP process identifies needs and desired outcomes for students and teachers and describes a plan that supports district and local school improvement plan priorities.¹⁶

The TIP also identifies materials and staff development resources needed and an evaluation plan to determine ongoing changes needed to adjust the plan. The completed TIP provides a carefully developed set of individual staff development needs for teachers to pursue when implementing technology.

The TIP process evolved from extensive research on the application and integration of technology into teaching and learning. The process was developed in the South San Fran-

cisco and Monterey Peninsula Unified School Districts and then adapted to the *Model Technology Schools in California* and the *Statewide Telemation Project*. Currently the TIP process is being applied to the NSF-supported model technology schools project in DoDDS, as well as the DoDDS President's Technology Initiative testbed sites. TIPs apply national, state, or local curriculum standards with some application of selected desirable or exemplary courseware to support and expand learning related to those standards. Each TIP is also based on the specific instructional needs of teachers and students and supports the local school-wide instructional improvement plan. The TIP can be viewed as a separate "mini-project" with its own evaluation to be conducted by teachers.¹⁷

INCENTIVES FOR RESEARCH AND DEVELOPMENT

Funding for R & D in courseware development has been inconsistent and uncoordinated. The recent legislation known as the *Technology Literacy Challenge Grants* is promoting partnerships with business in the

development of courseware with an emphasis on online resources. The Department of Defense has recently funded President Clinton's *Courseware Development Project* within DoDDS at approximately \$20 million. This project is designed to promote evaluation and research on existing and emerging courseware and online resources. It is hoped that this will result in an array of new state-of-the-art learning technologies and integration strategies that can be adapted on a national basis. The program may also support expansion and scaling up of K-12 courseware emerging from NASA, NSF, DARPA (Defense Advanced Research Projects Agency, which funds research in DoDDS schools), and others.

NEXT STEPS

An examination of the current status of courseware suggests that the following activities may be productive in increasing the development of and access to effective educational courseware.

- A national courseware clearinghouse could be established that includes both commer-

Figure 2: Integrating Technology into the Curriculum

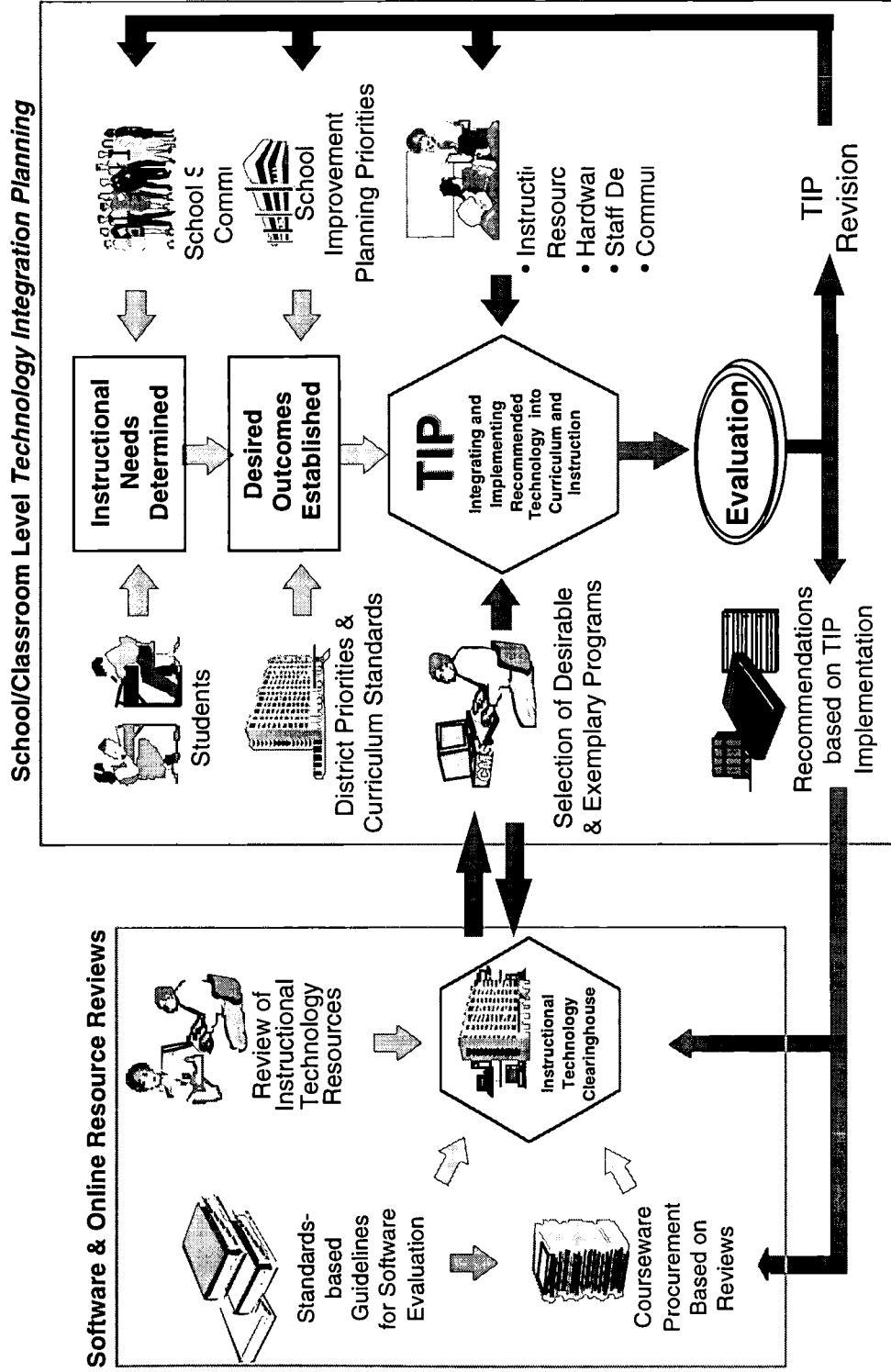

cial and public domain resources.

- Additional incentives could be provided to the courseware industry to produce additional products in partnership with national, state, and local education agencies.
- Interagency development of courseware could include the Department of Education, Department of Defense Educational Activities, National Science Foundation, NASA, and others as appropriate.
- The specific development needs for courseware that would meet current and emerging curriculum and instructional priorities at the national, state, and local levels could be determined.
- Assessment strategies should be embedded into new products and should reflect the tasks and applications intended by the products and that are linked to educational standards.
- A national information and support system could be used to enable educators to access and use the courseware being made available through recent national and state educational technology initiatives.

1 U.S. Department of Education. *Getting America's Students Ready for the 21st Century, Meeting the Technology Literacy Challenge*. June 1996.

2 John Cradler and Elizabeth Parish. *Telecommunications Technology and Education: What Have We Learned from Research and Experience?*, WestEd Regional Laboratory, October 1995.

3 John Cradler. *Policy Recommendations for Program Improvement with Educational Technology in California Schools*. Policy Analysis for California Education, 1988.

4 C.W. Fisher and others. "Teaching Behaviors, Academic Learning Time and Student Achievement: An Overview, in *Time to Learn*. Washington, DC: National Institute of Education, 1980.

5 Robert E. Slavin. "Making Chapter 1 Make a Difference," *Phi Delta Kappan*, October 1987.

6 W. Harvey. *Designing Educational Software for Tomorrow*. SRI International, May 1985.

7 D. Considine. "Media, Technology, and Teaching: What's Wrong and Why," *School Library Media Quarterly*, Summer 1985 and C. Mojkiwski, "Technology and Curriculum: Will the Promised Revolution Take Place?" *NASSP Bulletin*, February 1987.

8 A few other states and some national agencies provide clearinghouses that serve as a catalogue of resources without reference to curriculum standards and alignment. These clearinghouses do not rate the courseware against a set of criteria, but do provide annotations and descriptions of the courseware.

9 The curriculum frameworks were developed over the last decade by teachers and subject area experts and were designed to articulate rigorous academic content and exemplary teaching strategies. These voluntary frameworks are linked to staff development, the state assessment program, and the state textbook adoption process. National education standards include those of the National Council of Teachers of Mathematics, the National Science Teachers Association, and the New Standards Project.

10 *CITC Guidelines for the Evaluation of Instructional Technology Resources for California Schools*, 1997.

11 The rubrics with complete operational definitions can be

found in the "CITC Guidelines for the Evaluation of Instructional Technology Resources for California Schools (1997)."

12 U.S. Department of Education, 1996.

13 The CITC data base is available from <http://tic.stan-co.k12.ca.us>. The CITC is directed by John Vaile and Ann Lathrop.

14 More information is available from cradler@cerfnet.com.

15 Eva Baker, Joan Herman and Maryll Gearhart. "Does Technology Work in Schools? Why Evaluation Cannot Tell the Full Story," in Charles Fisher and others (eds.), *Education and Technology: Reflections on Computing in Classrooms*. San Francisco, CA: Jossey-Bass, 1996.

16 School improvement plans are the school-wide plans used in most states to annually define a school-wide instructional program.

17 For more information on TIP, see John Cradler and Elizabeth Parish. "Planning and Instructional Integration," in *Telecommunications and Technology in Education: What Have We Learned from Research and Experience?*, WestEd Regional Laboratory, October 1995.

The Costs of Educational Technology

Two of the *Technology Literacy Challenge* goals call for installing computers in all American public schools and connecting them to the information superhighway. This will require significant resources. But how much will it cost? Some of the answers can be found in several sophisticated studies which model costs.

In this section of the report we review several major national studies, the experience of the state of California, as well as that of two school districts to estimate costs for different scenarios of technology deployment. We also discuss some cost and practical issues related to cable and wireless technologies, and consider some of the cost concerns of rural parts of the country. Finally, some information on how various school districts have reduced technology costs is provided.

ESTIMATING THE COSTS OF TECHNOLOGY IN OUR SCHOOLS

Technology costs depend on a number of factors, such as the quality and quantity of purchases of hardware — e.g., computers, local area networks (LANs), servers, routers,

and other connections — the quality and frequency of teacher and staff training, and the time period over which the deployment occurs. Courseware (such as instructional software, CD-ROMs, videos, or electronic services), the bandwidth of the connection (see the box on

this page), and the type of connectivity (e.g., telephone lines, cable, or wireless) also affect costs.

Other cost factors include improvements to the existing school infrastructure (e.g., electrical heavy-ups, retrofitting for asbestos removal, cooling and

THE BANDWIDTH FACTOR

Bandwidth refers to the amount of information that can be transmitted over a network within a given time. The concept is often illustrated by a pipe that permits only a certain amount of water to flow through it. Only a certain amount of digital information, or “bits,” can be transmitted through wires or cables per second. Typical telephone lines most commonly move information at 14.4 thousand bits per second (kbps), which means about a 30-second wait for one full-color computer screen of information from the Internet. This capacity falls within the definition of *narrowband*.

Higher phone line speeds, ranging from 56 kbps up to 1.5 million bits per second (mbps), are referred to as *wideband*. Included in this range are the ISDN (Integrated Services Digital Network) lines which provide for speeds from 56 to 128 kbps, significantly reducing the time required to receive information, and T-1 lines at over 1.5 mbps, which allow 24 students fast, concurrent access to networks.

Although definitions vary, *broadband* generally refers to speeds greater than 1.5 mbps and is associated with fiber optic or coaxial cable. It permits rapid transmission of data, voice, and video for advanced technology uses such as desktop videoconferencing, networked simulations, and virtual field trips.¹ Authors of the TIAP report (see below) use Tolstoy's *War and Peace* to distinguish between wideband and broadband transmission rates. Transmitting the entire contents of that classic work requires 26 seconds via wideband, but only one second by broadband.²

The cost of broadband is, as expected, significantly higher than lower capacity access, and until fairly recently was considered an unnecessary luxury for schools. Widespread deployment of broadband to schools, however, is now a serious and more available option. Some cable companies are offering free services, and the telephone industry is developing next-generation Asymmetric Digital Subscriber Lines (ADSL), challenging cable speed, quality, and flexibility.

ventilation systems), ongoing technical support, maintenance, and repairs, hardware and software upgrades, as well as the initial cost of telecommunications connections and ongoing usage fees (for telephone, cable or wireless) and for Internet access.

The following section describes several models that have recently been used to estimate the costs of providing technology in our schools under several different scenarios and schedules. While the models and studies generally include the costs of hardware, teacher professional development, changes in building infrastructure, and wiring and LAN connections, there is considerable variation among the cost factors and pricing of the models. Readers who desire more than a general cost comparison are encouraged to consult the studies referenced.

COST MODELS

RAND Research.

Thomas Glennan and Arthur Melmed, on behalf of RAND's Critical Technology Institute, and in support of the White House's Office of Science and Technology Policy, developed a broad estimate of the costs of introducing technology

into schools.³ Beginning with technology currently in place, RAND developed a rough estimate of the cost of existing technology in schools in 1994-95:

- \$3.2 billion, about \$70 per pupil, or a little more than 1.3 percent of total expenditures

To project costs of a nation of technology-enabled schools, they examined the technology costs of eight schools considered exemplary users of technology, which were reported upon earlier by Keltner and Ross.⁴

The selection of exemplars was based on their breadth of technology used in instruction, the use of technology as an educational tool, and commitment to devoting the resources necessary to transform the school for full technology use. The schools, although not representative in a statistical sense, included a spectrum of student populations and grade levels. Their student-to-computer ratios ranged from 11 to 1, to 2 to 1. Findings are as follows:⁵

- Per-student costs for technology-rich schools range from \$180 to \$450, or from 3 to 8 percent of current per-pupil expenditures. The authors consider \$300 per student, or 5.3 percent of school budgets, as a plausible target.
- The costs of providing technology-rich learning environments are not inconsequential. Total costs to the nation range from \$10 to \$20 billion per year, or *from three to six times* what is currently spent.
- The cost of equipment, especially computer density, is the primary factor affecting costs.
- A second major factor affecting total cost is personnel. These schools needed full-time staff devoted to technology operations. In some cases they were newly hired; in others existing teachers took the responsibility.
- Staff development costs are about \$25 per student, assuming that teachers are compensated for this time, either by hiring a substitute or by a stipend for extra time spent.
- Per-student software costs are low, between 4

and 10 percent of total technology costs.

- Decisions to fund educational technology are not necessarily correlated with ability to pay. Determinations that technology is important can lead states and districts to allocate increased proportions of their resources to technology.

The McKinsey Models⁶. The McKinsey & Company management consulting firm reported in 1995 on the costs and feasibility of providing all of the nation's K-12 public schools access to the national information infrastructure (NII) over the next five to 10 years.

The report describes four deployment models that assume different time-frames (by the year 2000 and by the year 2005) and different levels of technology infrastructure, from multiple computers in each classroom to one multi-media lab per school. The models represent typical choices that schools are actually making and also point out the fundamental economic breakpoints among options. The highest capacities assumed are wideband

wireline WAN (Wide Area Network) connections (T-1 lines of 1.5 mbps) to schools in most cases, although some wireless radio costs were estimated for rural schools.

The four computer-based models and their aggregate costs are described below:

- **The Lab:** one lab with 25 networked PCs per school by the year 2000.
- **The Lab Plus:** the above lab plus one computer and modem per teacher by the year 2000.
- **The Partial Classroom:** assumes one-half of each school's classrooms are connected with networked computers by the year 2000 at a ratio of one PC to five students. Each school has a 1.5 mbps connection and an Ethernet LAN across and within all classrooms.
- **The Classroom:** all of the above with *all* classrooms having a 1 to 5 computer to student ratio.

Costs for each model are shown in Table 1. All four models include a district server and LAN; school server and

Table 1: Costs of Four Technology Deployment Models

Model	National Costs \$ Billions		Cost Per Average School \$ Thousands		Cost Per Enrolled Student Dollars		Percent of K-12 Budgets, 2000
	Initial	Ongoing	Initial	Ongoing	Initial	Ongoing	Percent
Lab	11	4	125	45	225	80	1.5
Lab Plus	22	7	255	85	460	150	3.0
Partial Classroom	29	8	340	90	610	155	3.4
Classroom	47	14	555	165	965	275	3.9

Source: McKinsey & Company, *Connecting K-12 Schools to the Information Superhighway*, 1995.

peripherals; professional development; and support. The deployment phase is five years for the first three models and 10 years for the fourth model. Highlights are provided below:

- The cost of even the most ambitious scenario is a relatively small portion of the public education budget.
- Depending on the scenario selected and speed of its deployment, the costs of connecting all K-12 public schools could range from 1.5 percent to 3.9 percent of the total K-12 budget nationwide.
- The biggest financial tradeoff hinges on how far into the school the technology is deployed, i.e., to a lab, a classroom,

or all the way to each student's desk.

- Annual per-school costs range from \$45,000 to \$165,000 for the lab and classroom models, respectively, and annual per-student costs are \$80 to \$275, respectively. Initial deployment costs per school are \$125,000 for the lab and \$555,000 for the classroom model. Similarly, per-student initial costs are \$225 and \$965, respectively.
- The largest upfront cost is the purchase and installation of hardware. Computers constituted about 55 percent of total hardware costs; printers, scanners, security systems, and furniture stations make up 25 percent; and 20 percent goes for retrofitting (upgrades for electrical,

heating, ventilation, and air conditioning).

- The largest ongoing cost is support and development of teachers and other school professionals.
- The cost of connection to the school (e.g., Internet access, telephone bills) is a relatively small portion of overall expenditures (e.g., from 4 percent to 7 percent of initial and ongoing costs, respectively, for the classroom model).

The MIT Models.

Lee McKnight and Russell Rothstein, of MIT's Research Program on Communications Policy, have collaborated for several years on the development of cost-benefit models for K-12 networking. The present discussion is based on

their most recent publications.⁷ These authors developed five models for connecting schools to the information super-highway using no greater than **wideband** connectivity (i.e., neither internal nor external connections exceeded 1.5 megabits per second).

The models proceed from stand-alone computing to ubiquitous networking, each with a different level of technical complexity, cost, and functional capability. They were built using data from a sample of technologically advanced school districts and schools. For each model, a range of one-time and annual costs was computed, from which one national cost to network all U.S. schools was extrapolated.

Each successive model presents an expansion of the features and capabilities available with expanded digital telecommunications infrastructure. All models use a "star" network architecture, whereby two to 10 schools are connected to a hub, which typically resides at the school district office. In large districts, multiple clusters of four to six schools are each connected to a group hub that is likely housed at the district office. Each

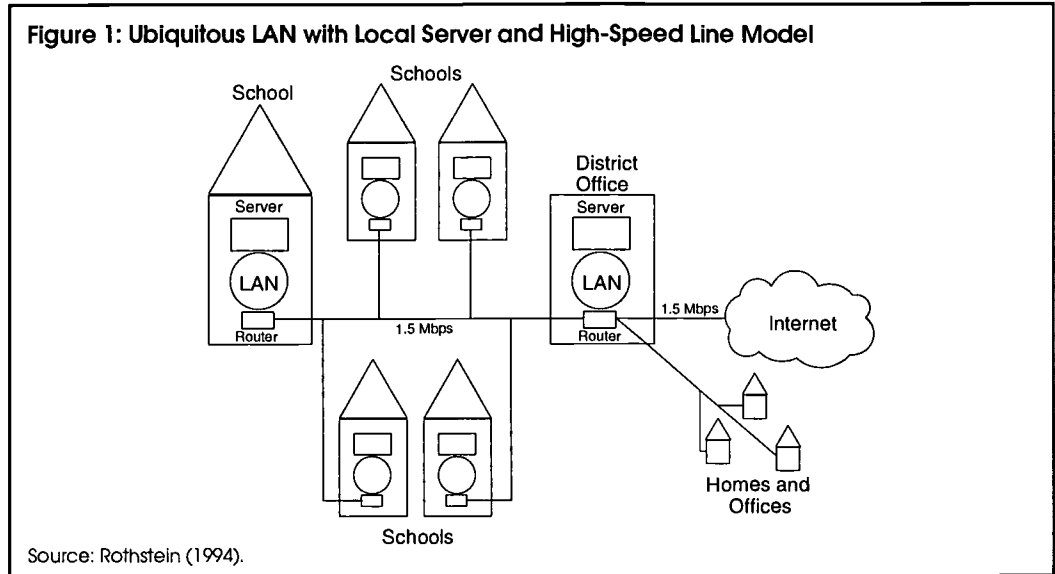

school's LAN is thus connected to a district office hub, and every classroom is connected to every other classroom in the school as well as to the central office.

The models are based on costs for a typical school and school district and represent average costs of all U.S. schools and districts. Schools' existing computer and networking capacities are taken into account in estimating costs. Costs of software are not included, assuming that "freeware" browsers and E-mail applications are downloaded from the Internet. The authors acknowledge that cost analysis of other software should be included in future models.

Five models are listed below, and described in the Appendix, which

provide increasing quality of service to schools. The less advanced models require relatively few computers per student and lower network connection speeds. As they increase in complexity, the models require more computers per student and higher connection speeds. Figure 1 illustrates the most complex, high-speed model.

— **Single PC Dialup**

— **LAN with Shared Modem**

— **LAN with Router**

— **LAN with Local Server and Dedicated Line**

— **Ubiquitous LAN with Local Server and High-Speed Line** (Figure 1)

Analyses of the models show that:

- The most significant hurdle a school will face in implementing a high-level model is the initial investment cost of the network and computers.
- The largest one-time costs for building the network are training and retrofitting.
- Support of the network is the largest ongoing annual cost. Over the first five years, support and training comprise 46 percent of the total costs of networking schools.
- There are two major jumps in the costs of networking a school: The first arises when the school installs a LAN, to meet the \$20,000 to \$55,000 installation costs per school, and to

employ full-time support staff at \$60,000 to \$150,000 per school district. The second jump occurs when PCs to support widespread concurrent network access are purchased. Hundreds of thousands of dollars will likely be needed to provide multiple PCs in every classroom. In addition, many schools will need major electrical work, possibly exceeding \$100,000.

- Start-up costs increase at a faster rate than ongoing costs as network complexity increases. One-time start-up costs of less complex models are two to three times ongoing costs, but for the more complex fourth and fifth models, one-time costs are five to 15 times the ongoing costs.
- The cost of the network hardware is only a small fraction of the overall costs for connecting to the NII.
- Since costs for telecommunications lines and services represent only 11 percent of the total costs, tariff rate reductions will have a relatively small impact.

The TIAP Models.

Models and costs of providing fiber-optic **broadband** access to public schools via local

telephone companies were developed by the Telecommunications Industries Analysis Project (TIAP).⁸ The type of high-speed broadband referred to in these models (greater than 45 mbps) provides enough bandwidth for data transfer, faxing, voice communications, and two-way video services.

Three access-to-technology scenarios (for one, seven, or 26 computers per classroom) provided according to two schedules (five years and 20 years) were modeled and costed out. One computer per classroom is called the "teacher-only access" scenario; seven computers per classroom is called the "cluster-of-students" scenario; and 26 computers per classroom is called the "universal access" plan.

The first deployment schedule is a five-year accelerated plan. It assumes that schools will have broadband access and equipment within five years and that the deployment will be uniform throughout the period.

In this scenario, new access technologies are provided to schools long ahead of their deployment to the rest

of the nation. For comparability with the 20-year plan, costs for the subsequent 15 years have been included in the five-year plan estimates. The 20-year schedule assumes that all schools will be equipped by the end of 20 years, matching the pattern of deployment to the nation. Both schedules assume a nationwide, ubiquitous deployment over a 20-year period.

Costs to both schools and local telephone companies are estimated by this study, unlike those previously discussed. These are admittedly "bare bones" models that focus on installation costs and do not include ongoing expenses for maintenance and operations. The current installed based of PCs in the classroom is not taken into account. Unknown or speculative costs, such as telecommunications rates based on possible future discounts to schools are also not included.⁹ Estimates include costs for hardware and teacher development, expenses for software and Internet access, and costs for local telephone companies to upgrade their networks to provide broadband services to schools. Findings of the study show that:

- Acceleration of deployment to the schools produces significantly higher costs. This is due to the fact that more equipment is purchased in the early stages when prices are higher and there will be little sharing of common facilities with other customers.
- Most of the cost of providing new technologies is driven by two factors: deploying technologies too fast, and providing schools with computing equipment, wiring, and training.
- Total costs for the five-year accelerated deployment plan (extended to include costs over 20 years and averaged for comparison purposes) are \$1.43 billion per year for the "teacher-only access" scenario, \$3.5 billion for the "cluster of students" model, and \$10.2 billion per year for the "universal access" scenario (Figure 2)
- Total costs for the 20-year deployment plan averaged over 20 years would be \$735 million per year for the "teacher-only access" scenario. The average annual cost of the "cluster of students" model is \$1.9 billion; and the "universal access" plan would

average \$5.9 billion per year (Figure 2).

- As expected, the higher the density of computers per classroom, the higher the cost. TIAP's estimates show that, regardless of the deployment plan, the "universal access" scenario costs approximately *three times as much* as the "cluster-of-students" scenario and *seven to eight times as much* as the "teacher-only" scenario.
- The average incremental investment cost per student over the 20-year period of each deployment plan ranges from \$387 for the "teacher-only access" scenario over the 20-year deployment plan, to \$4,019 per student for "universal access" under the accelerated five-year plan.

CALIFORNIA'S EXPERIENCE

The California Education Technology Task Force released a report in July 1996 calling for an investment of nearly \$11 billion to integrate technology into K-12 classrooms across the state over the next four years. The detailed cost work sheet, developed in determining the four-year budget, is included in the report.¹⁰ The funds required were to be apportioned into the three major categories:

- Hardware and Telecommunications Infrastructure (\$5.7 billion or 52 percent)
- Learning Resources and Services (\$2.9 billion or 27 percent)
- Staff Development and Support (\$2.3 billion or 21 percent).

The Task Force called for equipping every classroom and school library with capability for interactive, high-speed transmission of full-motion video, voice, and data. Six to eight networked multimedia computers would be provided for every class, along with a scanner, printer, TV, telephone, and other equipment. Every five classrooms would have a color printer, VCR, video camera, video disc player, and LCD panel. High speed copiers and fax machines would be available for every 15 classrooms. In addition to school and district technical staff, \$2,000 per person would be provided for staff support, Software valued at \$2,000, upgrades at \$200, and other multimedia resources at \$500 per classroom were budgeted. Connection charges of \$1,265 per month were also included.

Figure 2: Average Annual Costs for Fiber-Optic Broadband Deployment to all U.S. Public Schools with Three Scenarios and Two Deployment Schedules

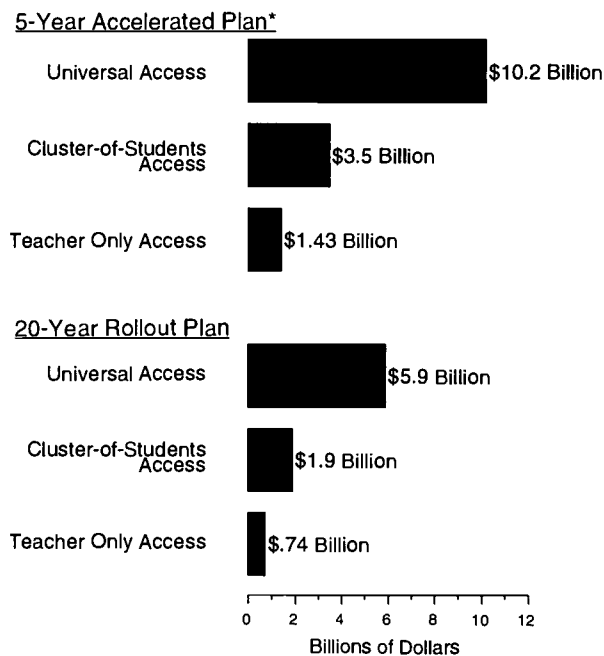

*For comparability with the 20-year plan, costs for the subsequent 15 years have been included in the five-year plan estimates.

Source: Telecommunications Industries Analysis Project, "Schools in Cyberspace: The Cost of Providing Broadband Services to Public Schools." Presentation to the NARUC Meeting, San Francisco, California, 1995.

For details on two technologies that are relevant to considerations of technology deployment in schools — cable and wireless communications — with the experience of two school districts with wireless technologies, see boxed descriptions.

URBAN/RURAL COST ISSUES

Telephone and cable connections to the NII are much more costly when extended to the vast expanses of rural America, with its fewer

and smaller schools. An analysis that illustrates these cost disparities was conducted by the Rural Policy Research Institute (RUPRI) at the University of Missouri-Columbia.²¹ This study was initiated to inform the Federal Communications Commission of the negative cost disparities in telephone rates experienced by rural schools and to suggest a way to determine equitable discounts, as required by the Telecommunications Act of 1996.

RUPRI researchers examined the numbers of schools in seven states²² that fall into "high-cost" telephone service areas as defined by the National Exchange Carriers Association. ("High-cost" refers to service areas where costs are greater than 114 percent of the national average cost per loop.) The schools in the high-cost areas were then categorized according to their location in a metropolitan area or non-metropolitan area.

As shown in Figure 3, 31 percent of schools in high-cost areas are located in metropolitan areas, compared with 46 percent in non-metropolitan areas. In metropolitan areas, only 21 percent of large central city schools are in high-cost areas, compared to 58 percent of urban fringe, mid-size central city schools. In the non-metropolitan areas, 56 percent of the rural schools are in high-cost areas.

ECONOMIES IN EDUCATIONAL TECHNOLOGY FUNDING

Several studies reported on how some school districts reduced educational technology costs. These include:

- adopting the star architecture design whereby

multiple schools connect through a single hub, schools share network costs, and each school pays less for its share

- sharing resources between multiple networks (data, voice, video). There is little additional cost for adding needed telephone lines when a school installs a LAN and puts computer data connections in classrooms
- coordinating purchasing at the state level. Schools in North Carolina and Kentucky were reported to have saved 20 to 50 percent by purchasing services and equipment at the state level
- negotiating volume discounts and sharing links and staff at the district level
- taking advantage of technical support available to K-12 schools from nearby colleges and universities
- taking advantage of free services offered by various telecommunications carriers such as free wireless phone service or free Internet connectivity
- taking advantage of special industry pro-

Figure 3: Percentage of Schools in High-Cost Areas, by Locality

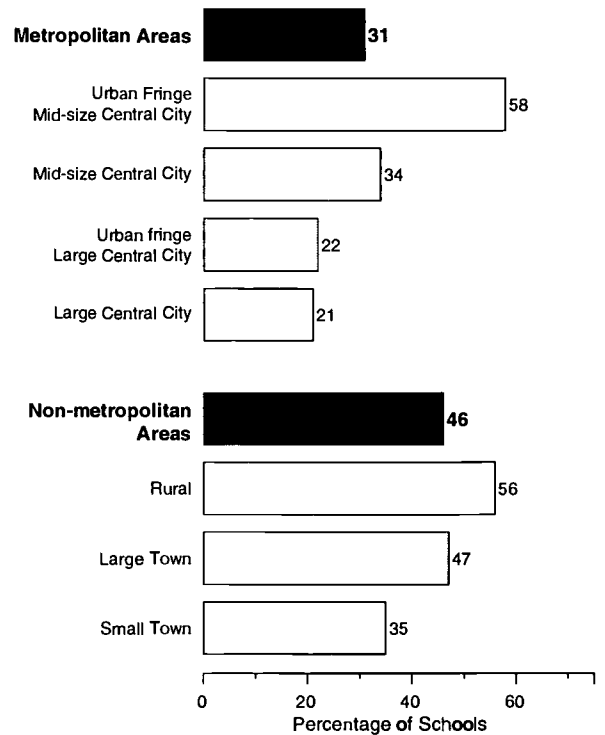

Source: Rural Policy Research Institute, *Preliminary Data Analysis of a National Merged Data Base as Applied to Implementation of the School and Library Discount Matrix in Sec. 254 of the Telecommunications Act of 1996*, Columbia, MO: University of Missouri-Columbia, to be published, May 1997.

grams such as: "Cable's High Speed Education Connection" program or AT&T's \$150 million 1995 pledge to spend \$150 million over five years to help connect schools to the network

- benefiting from local cable franchise agreements or "social contracts" with the FCC which require cable companies to provide free Internet connections or services as a condition of franchise renewal or special rates

1 McKinsey & Company, *Connecting K-12 Schools to the Information Superhighway*, Palo Alto, CA: 1995.

2 However, the TIAP authors define broadband as greater than 45 mbps.

3 Thomas K. Glennan and Arthur A. Melmed, *Fostering the Use of Educational Technology. Elements of a National Strategy*, Santa Monica, CA: RAND, Critical Technologies Institute, 1996.

4 B. Keltner, and R.L. Ross, *The Cost of School-Based Educational Technology Programs*, Santa Monica, CA: RAND, Critical Technologies Institute, 1996.

5 Note that Glennan and Melmed used annualized cost figures and amortized, rather than actual costs of hardware, software, teacher preparation, special furniture, and cabling. They acknowledge that ignoring significant one-time costs of rapid deployment does not provide an accurate picture of the

CABLE CONNECTIONS

The lines which deliver cable television to homes, schools, and businesses can also connect to the NII. A cable modem is used to link computers to cable lines in much the same way ordinary modems connect computers to telephone lines. These modems provide very fast, digital access to the Internet — hundreds of times faster than conventional telephone modems. The cable industry uses the example of downloading a picture of the Mona Lisa, that would take 1.4 hours to transfer over typical phone lines. Via cable modem, this down-load takes only 18 seconds. Cable modems cost about \$500 each and allow the transmission of full-motion video.¹¹

Cable in the Classroom, a \$420 million industry public service effort was launched in 1989. Free cable connections, commercial-free educational programming, and teacher training workshops were offered to schools across the country. In July 1996, the cable television industry announced a new commitment, "*Cable's High Speed Education Connection*." The industry would equip, free of charge, at least one site in every consenting elementary and secondary school that is passed by cable with a cable modem. This cable modem provides 100 personal computers with basic high-speed access to the Internet.¹² Sixteen cable companies pledged to provide 3,000 schools in about 64 communities with Internet connections. The actual implementation of the program, however, has been slow, and is expected to take place gradually.

In addition to the cable modem to the school, each individual computer requires a cable modem at a current, but declining, cost of several hundred dollars. The industry estimates a cost of \$125 for wiring an individual classroom, assuming the school already has a basic cable connection. An amplifier would cost an additional \$60. Trenching, if required to connect classrooms in separate buildings, would increase the cost to about \$700 per classroom.

There are technical and financial hurdles with cable that still must be resolved, and analysts have mixed views about the business's prospects.¹³ Experts report considerable "noise" with less than the highest quality cable modems. Difficulties occur in the two-way interactivity on cable that is essential for educational purposes.¹⁴ Telephone lines are still necessary in the vast majority of systems to allow for student response. Upstream amplifiers must be installed for every 2,000 feet of cable in order to enable interactivity.¹⁵ Thus schools would need to install a double infrastructure until two-way cable can be activated.

WIRELESS CONNECTIONS

Wireless radio connections are another option for schools to obtain NII access. Both internal wireless LANs and external wireless connections are being used to solve problems and save money under certain circumstances.

Old buildings, for example, where the hefty cost of asbestos removal required for wiring greatly exceeds that of wireless LANs, are particularly appropriate candidates. Wireless LANs, however, are generally not very popular in schools because of their relatively high cost compared to wired alternatives. An ethernet card for a PC now costs about \$20, whereas the average wireless LAN card costs \$500–\$700 and provides less than equivalent performance.¹⁶

The unobstructed terrain and less heavily used radio spectrum desired for effective wireless communications are most frequently found in non-urban or suburban areas. Rural schools, therefore, that often encounter prohibitively high prices for installing and sustaining dedicated circuitry due to their geographical isolation, are likely to benefit from wireless technology solutions. In urban or suburban environments, however, fixed wireless solutions can be limited due to possible low reliability, requirements for a clear line

level of front-end investment and estimate that if schools start with virtually no equipment and phase the equipment and training in over three years, costs might be about 70 percent greater in each of the first three years.

- 6 McKinsey & Company, *Connecting K-12 Schools to the Information Superhighway*. Report prepared for the National Information Infrastructure Advisory Council, 1995.
- 7 R. Rothstein, "Networking K-12 Schools: Architecture Models and Evaluation of Costs and Benefits," Master's Thesis, MIT Sloan School of Management and the Technology and Policy Program, Cambridge, MA, 1996, and R. Rothstein and L. McKnight, "Technology and Cost Models of K-12 Schools on the National Information Infrastructure," *Computers in the Schools*, 12(1/2) 1996.
- 8 Telecommunications Industries Analysis Project, *Schools in Cyberspace: The Cost of Providing Broadband Services to Public Schools*. Presentation at the NARUC Meeting, San Francisco, CA, July 1, 1995.
- 9 Telephone conversation with Carol Weinhaus, TIAP Director, January 16, 1997.
- 10 California Department of Education, *Connect, Compute, and Compete: The Report of the California Education Technology Task Force*, Sacramento, CA, 1996.
- 11 Lady Kereford, "Area Schools to Get Glimpse of Future Thanks to Cable's Internet Modem Offer," *Nashville Banner*, July 10, 1996.
- 12 "Cable Industry to Give Schools Free Internet Access," *The New York Times* on the web, July 9, 1996.
- 13 "Cable Firms to Wire Schools to Internet," *Orange County Register*, July 10, 1996.
- 14 Remarks by Stagg Newman of Bellcore at the FCC Bandwidth Forum, Washington, D.C., January 23, 1997.
- 15 Conversation with Wendell H. Bailey, Vice President for Science & Technology, National Cable Television Association, February 28, 1997.
- 16 Communication with Dewayne Hendricks of Warp Speed Imagineering, Fremont, CA., and

WIRELESS CONNECTIONS, CONT.

of sight, the fact that only data and digitized video can be transmitted, and the potential for overloading the network due to heavy usage.¹⁷

The only data found to illustrate cost comparisons of wireless and wired connectivity solutions for schools were case studies from the National Science Foundation (NSF)-supported *Wireless Field Test for Education*. This project is intended to provide comparative data on Internet connectivity by incorporating wireless links into existing or extended wired networks and Internet services in order to collect realistic data under operating conditions. The investigation is being conducted among rural school districts in Colorado's San Luis Valley and the urban district of Colorado Springs.

The *Air Academy School District in Colorado Springs* provides the best cost comparison data to date. This district of 14,000 students and 28 buildings completed installation of a nearly totally wireless wide area network in late August 1996.

Links between 20 of its sites permit communication among schools and to and from the Internet. Of two bids received, one was from a telephone company for an all-fiber T-1 installation providing between-school links, the servers and LANs, for \$1.5 million plus \$75,000 per year in monthly service costs via a required five-year, \$375,000 contract. The other bid, which was accepted, was \$601,000 for no-communications-cost wireless links between the buildings and the servers and wired LANs within the buildings. The cost of wireless equipment (a combination of microwave and spread spectrum radios plus antennas and cabling) was about one-third of the total cost.¹⁸ The district headquarters serves as the hub, which is linked to the Internet via two T-1 wired circuits to the MCI Internet Point of Presence in downtown Colorado Springs. The cost per school for the 20 sites was approximately \$10,000. An NSF researcher reports that the first year's operation found no failures, robust signals, no degradation from weather, and ample bandwidth for Internet multimedia.

In summary, the district has a reliable, economical, high-bandwidth, Internet and Intranet, wirelessly linked wide area network at one-quarter the initial cost of a wired telephone network and with no subsequent costs except routine maintenance.¹⁹

A second case study, of the Belen, New Mexico, Consolidated School District, involved providing LANs to all eight schools, linking the schools to each other and to one hub school, and connecting to the Internet. Bids ranged from \$800,000 for a microwave wireless solution, \$550,000 for a hybrid wired solution, and \$300,000 for a no-license wireless solution. The ultimate cost of the latter accepted bid was about \$12,000 per school to get the spread spectrum radio network operating at T-1 speeds, and connecting all eight schools and the district headquarters. Startup software and antenna problems encountered the first year of operation were resolved satisfactorily.²⁰

The researcher estimates that wireless can save from 20 to 40 percent of the total cost of commercial telephone Internet connectivity (the local loop cost comparison). The Wireless Field Test Project will produce diagrams as well as cost and throughput comparisons in October 1997. In addition, a "cookbook" is being developed, so that schools and libraries can make better use of wireless than they have in the past.

Co-Principal Investigator of the NSF Wireless Field Test for Education, on April 2, 1997.

17 McKinsey & Company, 1995.

18 Unlike most radios today, which transmit on just one frequency, spread spectrum radios transmit on many frequencies at the same time. They can thus increase efficiency by sending the same amount of information as conventional radios, using much less power.

19 David Hughes, *Report on Air Academy School District Microwave and Spread Spectrum System*, August 28, 1996. <http://wireless.oldcolo.com>.

20 David Hughes, *The Connected Schools of Belen, New Mexico. A Wireless Success Story*, May 20, 1996. <http://wireless.oldcolo.com>.

21 The Rural Policy Research Institute, *Preliminary Data Analysis of a National Merged Database as Applied to Implementation of the School and Library Discount Matrix in Sec. 254 of the Telecommunications Act of 1996*. Columbia, Missouri: University of Missouri-Columbia, to be published, May 1997.

22 The states included were: Florida, Maine, Missouri, Nebraska, Nevada, Texas, and West Virginia.

Appendix

Costs in the McKinsey Models were evaluated in detail across six infrastructure elements:

- (1) the **connection to the school** (i.e., the WANs that will connect schools to each other, to their district offices, and to the NII). These are external connection costs including installation, access and usage charges for both the school and district. Wireline connections were mostly assumed, but 27 percent of the rural schools were estimated with wireless radio. Average current RBOC tariffs, decreasing by 3 percent per year, were the basis for cost estimates.
- (2) the **connection within the school** (i.e., LANs that will link computers within the given schools). These internal connection costs include materials and labor for installing LANs, such as cabling and network interface cards, as well as file servers (for both school and district), hubs, and routers. Both wireline and wireless LAN installation were estimated at about \$200 per node. \$63,500 per school was assumed for asbestos removal and retrofitting for one-half of the older buildings.

School servers (three in the Classroom model) were priced at \$3,200 each and district servers (two in the Classroom model) were 10,000 each.

- (3) the **hardware**, including the computers, printers, scanners, and other equipment needed for full functioning of the technology; Multimedia computers were costed at \$1,700 each; printers (one per classroom) were \$555 each; scanners (one per classroom) were \$675 each; furniture stations (one per computer) were estimated at \$355 each; and security systems (one per room) were \$350 each.
- (4) **content**, including software and on-line service charges; Costs of periodic software upgrades were included, and prepackaged software costs were considered interchangeable with those obtained through online services
- (5) **professional development** for teachers. Costs include those of substitute teachers (@\$100 per day) as well as support resources — 1/4 FTE in the Lab model and 1.5

FTE in the Classroom model — shared across the district to help teachers integrate technology into the classroom. Costs of training courses were also included.

- (6) **ongoing system operations**, including resources shared across the district dedicated to designing and operating the systems. Initial deployment costs for the Lab and Classroom models were estimated at \$5,300 for design and 1/4 FTE and 1/2 FTE respectively. The same FTEs continue on an ongoing basis.

For each element, costs of **initial deployment** (including the purchase and installation of equipment and first-year operating expenses), as well as **ongoing operations and maintenance** (including usage charges, equipment and content upgrades, and professional development and support) were estimated. Adjustments were made for declining prices in some elements and for increased costs in others, such as the greater costs of connecting older schools requiring retrofitting and asbestos removal. The models also took into account

the amount and quality of existing infrastructure for each element. These costs accounted for the growing student population, spread equipment costs over a 10-year period, and **assumed three percent inflation.**

MIT MODELS

Single PC Dialup.

The lowest cost, most basic connectivity option, with no internal LAN and a single connection to the district office over a modem and standard phone line. Only one person may use the connection at a time, and many of the benefits of connection to the information superhighway are not accessible. One-time installation costs range from only \$200–\$500, and annual operating costs from \$200–\$1,150, per school.

LAN with Shared Modem. Each school has a LAN, to which a 28.8 Kbps modem is connected. This gives Internet access to every computer on the network through the district server's 56 Kbps connection. The model, however, supports only a few users at a time, limited by the number of school phone lines. As in the previous model, only text-based Internet applications (e.g., E-mail, telnet, gopher) can be

utilized. The significant LAN costs include those of wiring (assuming category 5 copper wire), network cards for every networked computer, and hardware and labor, totaling \$400–\$500 per PC. For a school with twenty classrooms and 3-5 PCs in each, the total LAN costs are \$20,000–\$55,000. One-time installation costs range from \$22,300 to \$66,000, and annual operating costs from \$3,600–\$10,250 per school.

LAN with Router.

This model includes a router in each school, instead of a modem, connecting to the district office and providing concurrent Internet access to multiple users. Schools are connected to the district and the district to the Internet by 56 Kbps lines. More computers are now usable in classrooms, so this model estimates the purchase of 15 new PCs per school at favorable negotiated prices of \$1,000–\$2,000 each. Support and training costs increase with additional users, new dial-up lines are needed for remote access, and significant retrofitting costs are incurred for

electrical and climate control systems and enhanced security. One-time installation costs range from about \$47,000 to \$114,000, and annual operating costs from \$3,500 to \$18,250 per school.

LAN with Local Server and Dedicated Line.

This model provides a file server at each school, allowing much of the information to reside locally instead of at the district office, thus improving performance. A higher bandwidth connection (1.5 Mbps) from the district hub to the Internet permits the entire school to be served. Higher speed links enable the use of limited video, graphical and text-based network applications. As a result, an extensive training program and a well-staffed support team are required. Costs are increased due to the larger bandwidth connection and the need for retrofitting costs of the electrical and climate control systems and for increased security. One-time installation costs range from \$95,600 to \$222,000, and annual operating costs from \$4,000–\$13,250 per school.

Ubiquitous LAN with Local Server and High-Speed Line.

This model puts a PC on the desktop of every student and teacher and connects them to each other and to the Internet. A 1.5 Mbps line to the school supports large numbers of concurrent users, who are similarly connected to the Internet via the district hub. Assuming 500 students in an average school, every school requires about 450 new PCs for this model. The high speed line and the larger file server and dial-up system, to accommodate many students, teachers, and parents, who access the system remotely, significantly increase costs. Retrofitting, electrical, and air conditioning, and security costs are also substantial. One-time installation costs range from \$565,700 to \$1,277,000, and annual operating costs from \$14,000–\$50,000 per school.



U.S. DEPARTMENT OF EDUCATION
Office of Educational Research and Improvement (OERI)
Educational Resources Information Center (ERIC)



NOTICE

REPRODUCTION BASIS



This document is covered by a signed "Reproduction Release (Blanket)" form (on file within the ERIC system), encompassing all or classes of documents from its source organization and, therefore, does not require a "Specific Document" Release form.



This document is Federally-funded, or carries its own permission to reproduce, or is otherwise in the public domain and, therefore, may be reproduced by ERIC without a signed Reproduction Release form (either "Specific Document" or "Blanket").